



# Products catalogue



| detailing  
| accessories  
| technical products

| car workshop  
| wash agents  
| professional cleaning agents

**Dear Sir or Madam,**

We are pleased to present you the latest edition of our Export Products Catalog . This is a special moment for us as we have the opportunity to showcase a wide range of innovative solutions that have emerged from the continuous development of our company. We believe that our offer will not only meet but also exceed your expectations.

We are proud to announce that in 2025, we will begin production of our products in a new, expanded manufacturing facility. This represents a significant step forward in our history. The new investment will increase our production capacity, enabling us to enrich the range of products available under various brands. Thanks to these changes we are prepared better to meet the rapidly growing market demands. Our workforce is expanding, and with it, the company's turnover has exceeded 80,000,000 EURO.

However, the growth of our company is not only quantitative but also qualitative. We are deeply committed to adhering to the highest environmental and quality standards, as evidenced by our attainment of ISO 9001 and ISO 14001 certifications. These accolades are a testament to our dedication to environmental protection and care for future generations.

Our research and development efforts, conducted by a team of nine highly qualified experts, focus on creating innovative and environmentally friendly products. We are addressing global environmental challenges by offering products that combine high efficiency with responsibility for the natural environment.







We understand the importance of supporting our business partners, which is why we offer a wide range of marketing services aimed at achieving mutual success. We view our collaboration with you as a strong partnership based on mutual trust and shared values, allowing us to grow together and achieve even better results.

We warmly invite you to continue our collaboration and to follow our progress. Together, by caring for the future of our planet and the development of our business partners, we strive to become a leader in our industry and open new opportunities on the path to shared success.

**Jarostaw Nowakowski**  
General Manager of the Amtra Group



INTRODUCTION.....	2	<b>MIKALOR</b>	CLAMPS AND HOSE CLIPS.....	63
NEW IN THE OFFER.....	4	<b>MA PROFESSIONAL</b>	CLEANING AND DEGREASING.....	65
<b>MOJE AUTO INSENTI</b>			CONSERVATION.....	67
ORGANIC.....	7		LUBRICANTS.....	69
FRESH CRYSTALS.....	9		SOLID LUBRICANTS.....	71
WOOD.....	11		TABLE OF PROPERTIES OF MA PROFESSIONAL LUBRICANTS.....	73
SPRAY.....	13		SEALANTS AND ADHESIVES.....	74
<b>MOJE AUTO</b>			CLEANING AND DEGREASING.....	78
DASHBOARD CLEANING AND CARE PRODUCTS.....	15		OTHER SERVICE PRODUCTS.....	79
BODYWORK WASHING AND POLISHING.....	18		POWER STEERING FLUIDS.....	81
UPHOLSTERY CLEANING.....	19		COOLING SYSTEM PRODUCTS / OPERATING FLUIDS.....	82
PRODUCTS FOR RIMS / PRODUCTS FOR TYRES.....	20		VARNISHES.....	83
PRODUCTS FOR ENGINES / OUTER SURFACE CLEANING.....	21		TOOLS.....	85
AIR CONDITIONING AND AIR FRESHENING.....	22		STAINLESS STEEL HOSE CLAMP W4.....	86
MOJE AUTO NANO SILVER LINE.....	23		HOSE CLIP / STAINLESS JUBILEE CLIPS W2.....	86
WASHER LIQUID / GLASS WASHING AND POLISHING.....	24		<b>MA PROFESSIONAL PLASTIC CLAMPS.....</b>	<b>88</b>
OTHER MOJE AUTO PRODUCTS.....	25		<b>TECMAXX PLASTIC CLAMPS.....</b>	<b>89</b>
<b>MOJE AUTO DETAILER</b>			<b>TECMAXX</b>	
CAR COSMETICS.....	27		LUBRICATION AND MAINTENANCE OF MECHANISMS.....	91
MICROFIBRES.....	29		TECHNICAL CLEANING.....	95
WASHING GLOVES.....	31		ADHESIVES.....	98
APPLICATORS   CLEANING AND WASHING BRUSHES.....	31		<b>BONDINI</b>	
DETAILING BRUSHES AND ACCESSORIES.....	32		CYANOACRYLATE ADHESIVE FOR DIY AND CRAFT INDUSTRY.....	101
CLEANING AND WASHING BRUSHES.....	32		<b>CLINEX EXPERT+</b>	
DETAILING BRUSHES AND ACCESSORIES.....	33		PRODUCT LIST FOR CAR WASHES.....	103
<b>WINTER CARE PRODUCTS</b>			BODYWORK PREPARATIONS.....	104
DE-ICER / WINTER WASHER FLUIDS / OTHER WINTER PRODUCTS.....	35		WAXING PREPARATIONS.....	105
<b>RADIATOR COOLANTS RADIGARD.....</b>	<b>37</b>		PREPARATIONS FOR ENGINES AND RIMS / TYRES & RIMS.....	105
<b>RADIATOR COOLANTS MA PROFESSIONAL.....</b>	<b>38</b>		INTERIOR CARE PREPARATIONS.....	106
<b>MOJE AUTO VIRAGE CAR ACCESSORIES</b>			ACCESSORIES FOR CAR WASHES.....	107
CAR BULBS.....	41			
HYBRID WIPER BLADES.....	42			
HYBRID WIPER BLADES "U" TYPE.....	43			
FRAMED WIPERS.....	44			
PROFILED WIPER BLADES - BASIC.....	45			
CAR ACCESSORIES.....	46			
CAR ACCESSORIES - SAFETY.....	50			
CAR ACCESSORIES - TOOLS.....	55			
CAR ACCESSORIES - SEASON.....	59			

 <p>AIR FRESHNERS</p>	 <p>PROFESSIONAL CAR CARE</p>	 <p>DETAILING PRODUCTS &amp; ACCESSORIES</p>	 <p>CAR ACCESSORIES</p>	 <p>WINTER CARE PRODUCTS</p>
 <p>PROFESSIONAL PRODUCTS FOR CAR WORKSHOPS</p>	 <p>CLAMPS AND HOSE CLAMPS</p>	 <p>TECHNICAL PRODUCTS AND CHEMICALS</p>	 <p>ADHESIVES</p>	 <p>CHEMICALS AND PRODUCTS FOR CAR WASHES</p>

**MOJE AUTO - LATEST CLEANING PRODUCTS**

Discover our latest cleaning products! **Magic Gel** from **Moje Auto** is perfect for cleaning various surfaces, from dashboards to keyboards and phones. It removes dirt without leaving any traces and is safe for delicate materials. **AC Doktor foam** effectively neutralizes odors in air conditioning, refreshing the ventilation system. **The X-NEON wheel and tire cleaner** is easy to use, quickly cleans dirt and brake dust, leaving your wheels shining. All products are environmentally friendly and ensure efficiency with every use.

For more information, see pages 17, 20 and 22.



**MOJE AUTO DETAILER - COSMETICS AND ACCESSORIES FOR THE DEMANDING**

We present the expanded line of **Moje Auto DETAILER** products, including specialized microfiber cloths for various applications in car detailing. The range also includes **Moje Auto DETAILER X-NEON PRO - a wheel and tire cleaner** available in 750 ml and 5 l packages. These acid-free agents effectively remove dirt and brake dust, are safe for different types of wheels, and contain corrosion inhibitors. Perfect for quick wheel washing, with the possibility of application using a foam sprayer.

For more information, see pages 27, 29 and 30.

**TECMAXX - BRAND NEWS**



**Tecmaxx** presents a new line of products for maintenance, lubrication, and repair, responding to the growing needs of customers. The range includes: **Active Foam** (1 kg and 5 kg) - effectively removes dirt from various surfaces, ideal for professionals and hobbyists. **Rust Remover** (400 ml and 500 ml) - effectively removes rust and prevents its return, making it easier to loosen seized bolts. **Ceramic Grease** - in spray and tube, protects and lubricates machines, providing long-lasting protection against wear and corrosion. **Epoxy Adhesive** - quickly bonds metal parts, easy to apply with a syringe. **Compressor Oil** - ensures efficiency and long life of compressors. **Brake Cleaner** - cleans brake discs, increases brake performance, and improves road safety.

These new products from **Tecmaxx** result from innovation and a commitment to delivering high-quality products for professionals, automotive enthusiasts, and industry.

For more information, see page 92.



**MA PROFESSIONAL - EXPANDED RANGE**

We invite you to explore the new offerings from the MA Professional brand, providing solutions tailored to various needs. Our range includes high-quality greases, epoxy primers, DOT3 and DOT5.1 brake fluids, and acrylic paints in various colors. Our products ensure excellent protection and performance for equipment and vehicles. Thanks to our innovative formulas, we guarantee high efficiency and durability under different operating conditions. Choose the products that best meet your needs.

For more information, see page 71.



**MA PROFESSIONAL - USEFUL TOOLS**



The MA Professional brand introduces a new series of workshop tools designed for professionals. The range includes oil filter wrenches, insulating tapes, pliers with a cable for hose clamps, an inflation gun with a pressure gauge, a magnetic tool strip, a trim clip remover, a set of handle hooks, and an air blow gun. These tools aim to facilitate and streamline workshop tasks. This innovative series of tools from MA Professional is the key to more efficient work for every professional.

Equip your workshop with these new tools and discover how they can transform your work!

For more information, see pages 84 and 85.

**MA PROFESSIONAL - RADIGARD COOLANT FLUIDS**

RADIGARD coolant fluids are a new addition to the MA Professional product line. Available in two colors – green and red. RADIGARD fluids come in ready-to-use form and concentrate. They are compatible with any coolant color. These fluids provide excellent protection for the cooling system against corrosion. Suitable for all types of radiators and vehicles, they ensure optimal engine operating temperature. They complement the existing range of MA Professional coolant fluids, highly valued by professional users in service centers and automotive workshops.

For more information, see page 36.



# 100% Organic



**MOJE**  
**AUTO**

**INSENTI**  
french perfumes  
**100%**  
**Organic**

## scents

### of nature

Moje Auto INSENTI Organic is a collection of organic air fresheners. The products contain only granules of plant origin (from annual plants) soaked in natural fragrance oils. Organic granules have very good absorption, consistent hardness and excellent balanced scent release. The granules are also heatresistant and can be safely used in full sunlight.



[moje-auto.pl](http://moje-auto.pl)

**VANILLA**



KTM: **15-021**  
 Weight: 18 g  
 12 pcs



**SPRING FRESH**



KTM: **15-022**  
 Weight: 18 g  
 12 pcs



**ARCTIC FRESH**



KTM: **15-023**  
 Weight: 18 g  
 12 pcs



**CITRUS SQUASH**



KTM: **15-024**  
 Weight: 18 g  
 12 pcs



**BUBBLE GUM**



KTM: **15-025**  
 Weight: 18 g  
 12 pcs





**MOJE**  
**AUTO**



# scents

in the form of beads

**Moje Auto INSENTI** is a new brand of car air fresheners. Aroma beads soaked in original French perfume and enclosed in colourful sachet bags are perfect for car, home, office, etc. The long-lasting scent and ease of use are additional advantages of these air fresheners.



[moje-auto.pl](http://moje-auto.pl)

Available fragrances: Vanilla | New Car | Ocean | Strawberry | Black | Lemon & Mint | Bubble Gum.



**INSENTI FRESH CRYSTALS**

**VANILLA**



KTM: **15-001**  
Weight: 20 g  
24 pcs



**NEW CAR**



KTM: **15-002**  
Weight: 20 g  
24 pcs



**OCEAN**



KTM: **15-003**  
Weight: 20 g  
24 pcs



**STRAWBERRY**



KTM: **15-004**  
Weight: 20 g  
24 pcs



**BLACK**



KTM: **15-005**  
Weight: 20 g  
24 pcs



**LEMON & MINT**



KTM: **15-006**  
Weight: 20 g  
24 pcs



**BUBBLE GUM**



KTM: **15-007**  
Weight: 20 g  
24 pcs





# scents in bottles

**Moje Auto INSENTI** is a new brand of car air fresheners. Insent Wood are exquisite car perfume bottles. The intensive scent gradually diffuses from the subtle bottle throughout the cabin of your car or the rooms of your home or office, where it can also be effectively used.



[moje-auto.pl](http://moje-auto.pl)

**INSENTI WOOD**

**VANILLA**



KTM: **15-151**  
Capacity: 8 ml  
14 pcs

KTM: **15-101**  
Capacity: 8 ml  
24 pcs



5 905694 017653

5 905694 016755

**NEW CAR**



KTM: **15-152**  
Capacity: 8 ml  
14 pcs

KTM: **15-102**  
Capacity: 8 ml  
24 pcs



5 905694 017707

5 905694 016762

**OCEAN**



KTM: **15-153**  
Capacity: 8 ml  
14 pcs

KTM: **15-103**  
Capacity: 8 ml  
24 pcs



5 905694 017714

5 905694 016779

**STRAWBERRY**



KTM: **15-154**  
Capacity: 8 ml  
14 pcs

KTM: **15-104**  
Capacity: 8 ml  
24 pcs



5 905694 017660

5 905694 016786

**BLACK**



KTM: **15-155**  
Capacity: 8 ml  
14 pcs

KTM: **15-105**  
Capacity: 8 ml  
24 pcs



5 905694 017677

5 905694 016793

**LEMON & MINT**



KTM: **15-156**  
Capacity: 8 ml  
14 pcs

KTM: **15-106**  
Capacity: 8 ml  
24 pcs



5 905694 017684

5 905694 016809

**BUBBLE GUM**



KTM: **15-157**  
Capacity: 8 ml  
14 pcs

KTM: **15-107**  
Capacity: 8 ml  
24 pcs



5 905694 017691

5 905694 016816

**MIX OF SCENTS  
35 PCS SET**



KTM: **15-200**  
In a jar: 35 pcs



5 905694 017523



EXCLUSIVE  
Car and Home Air Freshener



# inseinti spray

refreshing mist

Moje Auto INSENTI Spray is an extensive collection of air fresheners closed in elegant glass bottles with atomizer, with a capacity of 50 ml. Perfumed fragrance compositions guarantee a long-lasting, pleasant scent. Excellent for use in the car, at home and in the office.



moje-auto.pl

**INSENTI SPRAY**

**VANILLA**



KTM: **15-171**  
Capacity: 50 ml  
☐ 12 pcs



5 905694 020387

**NEW CAR**



KTM: **15-172**  
Capacity: 50 ml  
☐ 12 pcs



5 905694 020394

**OCEAN**



KTM: **15-173**  
Capacity: 50 ml  
☐ 12 pcs



5 905694 020400

**STRAWBERRY**



KTM: **15-174**  
Capacity: 50 ml  
☐ 12 pcs



5 905694 020417

**BLACK**



KTM: **15-175**  
Capacity: 50 ml  
☐ 12 pcs



5 905694 020424

**BUBBLE GUM**



KTM: **15-176**  
Capacity: 50 ml  
☐ 12 pcs



5 905694 020431

**MIX OF SCENTS  
18 PCS SET**



KTM: **15-170**  
Capacity: 18 x 50 ml



5 905694 021001



[moje-auto.pl](https://moje-auto.pl)

# always well-maintained car

**MOJE AUTO** offers professional car care products for year-round maintenance, characterized by an optimal balance of excellent quality, price, and efficiency. The complete range includes several dozen products for washing, cleaning, and polishing both the exterior and interior elements of the car. Since 2013, the brand's ambassador has been **Kajetan Kajetanowicz**, the **WRC 2 Challenger World Champion of 2023**.

## COCKPIT WIPES GLOSS



Moist wipes for cleaning shiny dashboard with lemon or vanilla fragrance. Leave the surfaces shiny instantly. Antistatic. Convenient. Packaging guarantees durability.

Lemon



Vanilla



KTM: **19-056E**  
pkg 24 pcs  
10 pcs



KTM: **19-608**  
pkg 24 pcs  
10 pcs



## COCKPIT WIPES MATTE



Moist wipes for cleaning matte dashboard. Safe for plastic and vinyl. Antistatic. Convenient. Packaging guarantees durability.

Lemon



Vanilla



KTM: **19-068E**  
pkg 24 pcs  
10 pcs



KTM: **19-609**  
pkg 24 pcs  
10 pcs



## UPHOLSTERY WIPES



For express cleaning of upholstery. Safe for all surfaces inside the car, remove stubborn dirt. Packaging guarantees durability.

For cleaning and care of leather upholstery made of natural and synthetic leather. They clean deeply, and restore gloss and colour. Safe, they do not damage upholstery and plastics. Packaging guarantees durability.

KTM: **19-069**  
pkg 24 pcs  
10 pcs



KTM: **19-643**  
pkg 24 pcs  
10 pcs



## GLASS & LCD WIPES



They leave no streaks. Easy use. They remove stubborn dirt. For windows, headlights and mirrors. Packaging guarantees durability.

KTM: **19-057**  
pkg 24 pcs  
10 pcs



## STUBBORN STAIN WIPES



Easy to use. They remove stubborn dirt, oils and greases. Safe for the hands. Packaging guarantees durability.

KTM: **19-076**  
pkg 24 pcs  
10 pcs



## COCKPIT SHINE



How the nozzle-tip Moje Auto product works



How a competitive product works

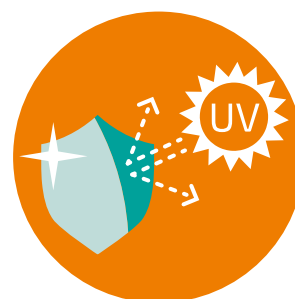

Dashboard cleaning agent. Cleans and maintains all plastic components inside the car. Antistatic agent. Reduces dust re-deposition. Leaves the cleaned surfaces shiny, adding some pleasant fresh fragrance. Delays the plastics aging process.

The new, two-phase formula penetrates the surface, protecting it from UV radiation, and leaving a polished layer on the outside. Contrary to traditional products, they do not contain solvents, which guarantees their excellent scent and complete safety for the user.



**Vanilla Shine** **19-562**  
Capacity: 500 ml  
24 pcs



**Strawberry Shine** **19-107E**  
Capacity: 600 ml + 25% FREE  
24 pcs



**Vanilla Shine** **19-009E**  
Capacity: 600 ml + 25% FREE  
24 pcs



**Lemon Shine** **19-563**  
Capacity: 500 ml  
24 pcs



**Apple Shine** **19-103E**  
Capacity: 600 ml + 25% FREE  
24 pcs



**Lemon Shine** **19-010E**  
Capacity: 600 ml + 25% FREE  
24 pcs



**Apple Matt** **19-019**  
Capacity: 600 ml  
24 pcs



**Black Shine** **19-571**  
Capacity: 500 ml  
24 pcs



**Arctic Shine** **19-576E**  
Capacity: 600 ml + 25% FREE  
24 pcs



**Black Shine** **19-113E**  
Capacity: 600 ml + 25% FREE  
24 pcs



**Fresh Shine** **19-012E**  
Capacity: 600 ml + 25% FREE  
24 pcs



**Sport Shine** **19-580**  
Capacity: 600 ml + 25% FREE  
24 pcs





## PROTECTANT GLOSSY



Dashboard care milk with natural waxes. It cleans and cares for plastic components inside the car. Adds gloss to unpainted bumpers, spoilers, rubber. Not greasy. It has antistatic properties and prevents dust deposition.

KTM: **19-001**  
Capacity: 750 ml  
12 pcs



## PROTECTANT MATTE



Dashboard care milk with natural waxes. It cleans and cares for plastic components inside the car, leaves the cleaned surfaces matte. Delays the plastics aging process. Suitable also for unpainted bumpers, spoilers, rubber. Not greasy. It has antistatic properties and prevents dust deposition.

KTM: **19-002**  
Capacity: 750 ml  
12 pcs



## PLASTIC CLEANER



Perfect plastic cleaner. Cleans all elements made of plastic (e.g. plastic, linoleum, synthetic leather, etc.).

KTM: **19-072**  
Capacity: 750 ml  
12 pcs



## MAGIC GEL FOR CLEANING



Magic gel for cleaning dashboards, cup holders or other hard-to-reach areas. It can also be used to clean keyboards, telephones, computers, mice and consoles. Magic Gel is an elastic mass which, thanks to its properties, perfectly penetrates every nook and cranny and pulls dirt and dust out of them. It leaves no residue and keeps hands clean. Safe for delicate objects. The magic gel is reusable, simply rinse and dry.

KTM: **19-661**  
Capacity: 200 g  
48 pcs



NEW

## COCKPIT MILK MATT



Effectively cleans all dirt on plastic components inside the car. Penetrates the structure of cleaned surfaces and protects them from getting dirty again. Has a self-cleaning effect by separating and repelling dust particles. Leaves the cleaned surfaces matte.

Vanilla Apple Black

KTM: **19-569** Cap.: 300 ml 24 pcs  
KTM: **19-570E** Cap.: 300 ml 24 pcs  
KTM: **19-614** Cap.: 300 ml 24 pcs



## COCKPIT MILK GLOSSY



Effectively cleans all dirt on plastic components inside the car. Penetrates the structure of cleaned surfaces and protects them from getting dirty again. Has a self-cleaning effect by separating and repelling dust particles. It adds some long-lasting gloss to the treated surfaces owing to silicone content.

Vanilla Apple Black

KTM: **19-573** Cap.: 300 ml 24 pcs  
KTM: **19-574** Cap.: 300 ml 24 pcs  
KTM: **19-615** Cap.: 300 ml 24 pcs



**ACTIVE FOAM  
NEUTRAL PH**

Concentrated, fragrant active foam with a neutral pH. Perfectly removes dirt, dust and other road sediments. It can be used in pressure washers and for manual washing.

**KTM: 19-607**

Cap.: 1 L

12 pcs

**ACTIVE FOAM  
FOR PRESSURE WASHERS**

Highly foaming product for frequent cleaning of motor vehicle bodies. It is highly effective owing to its unique composition. Perfectly removes dirt, dust and other road sediments. Intended for use in spray, pressure, foaming systems or for traditional, hand washing.

**KTM: 19-554**

Cap.: 1 L

18 pcs

**SHAMPOO WITH WAX**

The shampoo washes away the most stubborn dirt and sediments and adds gloss to the car body. It creates a protective wax layer. Adds long-lasting gloss. Biodegradable. Orange fragrance.

**KTM: 19-027E**

Cap.: 1,3 L

12 pcs

**CAR SHAMPOO  
WITHOUT WAX**

Washes away any dirt and deposits effectively. Regular washing allows for keeping the original gloss of car paint. Biodegradable. Orange fragrance.

**KTM: 19-029**

Cap.: 1 L

12 pcs

**WET WAX**

Triple-action polishing wax applied on wet coating. It accelerates drying of the car after washing, perfectly polishes the coating, restores the natural gloss, protects against unfavourable weather conditions. Fast and effective, keeps the paint in perfect condition. For all types of coating.

**KTM: 19-084**

Cap.: 750 ml

12 pcs

**BODYWORK BALM**

Liquid wax, which adds intense gloss to the coating, restores its deep colour and protects the coating against weather conditions. Its balm formula allows for spreading the product on the surface. It can be used on ordinary and metallised coatings.

**KTM: 19-586**

Cap.: 750 ml

12 pcs

**SYNTHETIC WAX  
QUICK DETAILER**

Quick synthetic wax protects the coating against dust deposition, adds gloss and protection of the coating immediately. Deepens the natural colour of the paint and protects it against UV radiation. It can be used on any exterior surfaces of vehicles such as windshields, plastic and rubber elements.

**KTM: 19-606**

Cap.: 750 ml

12 pcs

**CLAY BAR**

Clay for cleaning the coating, windshields and other body elements. It removes tar, traces of insects, road sediments and other dirt from the coating very thoroughly.

**KTM: 19-645**

Cap.: 60 g

40 pcs

**KTM: 19-613**

Cap.: 160 g

10 pcs



## UPHOLSTERY CLEANER ANTIBACTERIAL



Upholstery cleaner Antibacterico 3in1. Upholstery and plastic cleaner and sanitiser. The product has bactericidal and yeasitcidal properties.

OBTAINED PERMIT OF THE OFFICE FOR REGISTRATION OF MEDICAL DEVICES, MEDICINAL PRODUCTS AND BIOCIDAL PRODUCTS 8048/20.\*

KTM: **19-641**  
Capacity: 750 ml  
8 pcs 12 pcs  
5 905694 019404

## UPHOLSTERY CLEANER



Strong product for washing and cleaning upholstery 2 in 1. Effectively removes dirt and stains from deeper layers of fabric, keeping fabric seats, padding, vinyl upholstery and mats looking like new. Guarantees excellent cleaning effect. In the case of single stains, it can be used as stain remover. Do not apply on leather upholstery.

KTM: **19-051E**  
Capacity: 750 ml  
8 pcs 12 pcs  
5 905694 001805

## UPHOLSTERY CLEANER



Universal foaming agent for cleaning all types of upholstery. The strong foam effectively removes dirt and stains from deeper layers of fabric, keeping fabric seats, padding, vinyl upholstery and mats looking like new. Do not apply on leather upholstery.

KTM: **19-023**  
Capacity: 520 ml  
8 pcs 12 pcs  
5 905694 001225

## UPHOLSTERY FOAM



2in1 cleaning foam for upholstery and car mats. Owing to the highest quality components, it penetrates fabrics and cleans them, also neutralising unpleasant odours. It cleans effectively, restores colours, eliminates unpleasant odours. The foam is extremely easy to use owing to the convenient brush put on the packaging.

KTM: **19-589**  
Capacity: 520 ml  
8 pcs  
5 905694 015208

## LEATHER CONDITIONER



After cleaning with the product, leather becomes delicate and soft to the touch, and is also protected against moisture and more resistant to any dirt. It prevents biological corrosion.

KTM: **19-024**  
Capacity: 400 ml  
8 pcs 12 pcs  
5 905694 001232

## LEATHER CLEANER



Advanced formula used to clean and care for leather, prevent it from drying out, fading and cracking. It contains a highly concentrated emulsion with avocado oil which cares for leather and deepens its natural colour. The product forms a protective barrier from harmful UV radiation and oxidation.

KTM: **19-582E**  
Capacity: 250 ml  
8 pcs 24 pcs  
5 905694 012801

**WHEEL CLEANER STRONG**

**SUPER STRONG**



An acidic cleaner for car rims. Useful in washing aluminum and steel rims. Prevents corrosion, adds gloss and restores shine of cleaned surfaces.

KTM: **19-047**  
Cap.: 750 ml  
12 pcs



**WHEEL CLEANER NEUTRAL**



Effectively removes sediments from brake pads, tar, salt and mud. Safe for all types of rims and hubcaps.

KTM: **19-071**  
Cap.: 750 ml  
12 pcs



**WHEEL CLEANER RED**



Quick and economic cleaning liquid with the "bloody wheel" effect, which reacts with strong contaminants. Removes stubborn stains from all types of steel, aluminum, chromium-plated and varnished rims.

KTM: **19-601**  
Cap.: 750 ml  
12 pcs



**WHEEL AND TIRE CLEANER X-NEON**

**NEW**



A non-acidic product designed for efficient and easy cleaning of wheels and tires. It effectively eliminates stubborn dirt, brake dust, and other contaminants, leaving the wheels clean and shiny. It deeply penetrates the grime and removes even the most resistant impurities.

KTM: **19-678**

Cap.: 750 ml

12 pcs



KTM: **19-672**

Cap.: 5 l

2 pcs



**PRODUCTS FOR TYRES**

**TYRE SHINE**



Tyre maintenance agent for making your tyres shiny in a quick and effective way. The surface of rubber becomes flexible when applied regularly. The user only needs to spray the cleaned surface directly.

KTM: **19-022**  
Capacity: 520 ml  
12 pcs



**TYREPROTECTANT**



Tyre maintenance and care product. Restores a deep colour of your tyres, producing a subtle gloss effect. Thanks to silicone emulsion contents, the solution guarantees long-term protection against matting, discolouring or cracking. Thanks to its anti-static properties, the surface shined stays clean for a long time. Sufficient for even 40 tyres.

KTM: **19-585**  
Capacity: 750 ml  
12 pcs



**BLACK TYRE FOAM**



Tyre care foam that protects the tyre from aging, cracking and easy soiling. It protects against weather conditions and deposition of dirt and dust. Regular use allows regeneration of tyre rubber and restores the colour's intensity. The amount is sufficient for 30 tyres.

KTM: **19-584**  
Capacity: 520 ml  
12 pcs



## PRODUCTS FOR ENGINES



### ENGINE CLEANER



Effective product intended for washing engines and car components. It removes oils and lubricants from the cleaned surfaces and other persistent dirt perfectly and quickly. Biodegradable.

KTM: **19-048**  
Capacity: 750 ml  
12 pcs



### ENGINE DOKTOR



Engine regenerator, seals piston rings, increases compression and oil pressure. It restores power and acceleration.

KTM: **19-067**  
Capacity: 444 ml  
24 pcs



### MOTO START ENGINE START



Ether product for starting the engine. Safe for all types of engines. Effective at temperatures to -50°C.

KTM: **19-553**  
Capacity: 400 ml  
24 pcs



## OUTER SURFACE CLEANING

### BUMPER & SLATS



Restores the new look of plastic bumpers, spoilers and exterior trims in all colours. Forms a layer protecting against the harmful effects of weather conditions.

KTM: **19-021**  
Cap.: 400 ml  
12 pcs



### TAR & SAP



The product is intended for removing stubborn asphalt, tar and resin dirt from glass surfaces and coated elements. It is both efficient, quick, and safe in contact with car coating. Perfect for cleaning windshields, headlights, bumpers, spoilers, car body.

KTM: **19-108**  
Cap.: 200 ml  
24 pcs



### INSECT REMOVER



The product is intended for removing stubborn dirt from glass surfaces, as well as from painted, rubber and plastic elements. High efficiency and quick effects. Safe in contact with car coating.

KTM: **19-054**  
Cap.: 750 ml  
12 pcs



### PLASTIC & RUBBER BLACK



It restores the original colour and adds a subtle gloss. Adds protection against moisture, salt and negative weather conditions, and hampers dirt deposition. It is a perfect product for regeneration of all black plastic elements of the body, tyres and seals.

KTM: **19-644**  
Cap.: 250 ml  
24 pcs



**A/C CLEANER**



Air conditioning cleaner is the highest quality product with a bacteriostatic effect allowing for effective cleaning of the air conditioning system in the car. Kills bacteria and fungi.

KTM: **19-035**  
Capacity: 300 ml  
12 pcs



**A/C VENT CLEANER**



OBTAINED PERMIT OF THE OFFICE FOR REGISTRATION OF MEDICAL DEVICES, MEDICINAL PRODUCTS AND BIOCIDAL PRODUCTS 7432/18.\*

The product cleans ventilation ducts in cars, preventing development of bacteria. It leaves a pleasant fragrance. The product can be used in all car types and models, with and without air conditioning.

KTM: **19-075**  
Capacity: 600 ml  
20 pcs



**AC DOKTOR**



Active foam for cleaning and refreshing the air conditioning system. Effectively neutralises unpleasant odours caused by bacteria and fungi accumulated in the A/C evaporator. Quickly refreshes the entire air conditioning system, eliminating unpleasant odours and preventing them for a long time. It can be used for all types of air conditioning systems.

KTM: **19-675**  
Capacity: 500 ml  
20 pcs



**BIO ODOUR NEUTRALIZER**



Eco-friendly, alcohol-free formulation for neutralizing odours based on innovative biosurfactants. It is safe for the user and all surfaces. Neutralises unpleasant and difficult to control odours such as sweat, mould mustiness, animals, vomit, urine or food with an intense smell such as garlic or fish. Thanks to the use of biosurfactants, it not only neutralises unpleasant odours but also blocks their return.

KTM: **19-655**  
Capacity: 500 ml  
6 pcs



**CONCENTRATED AIR FRESHENERS**



Strongly concentrated air freshener with a very intense and long-lasting fragrance. Its specially selected composition neutralises unpleasant odours and reduces their deposition inside the car. Its unique fragrance lasts longer than in the case of traditional air fresheners.

Citrus



KTM: **19-603**  
Capacity: 500 ml  
6 pcs



New Car



KTM: **19-604**  
Capacity: 500 ml  
6 pcs



Black



KTM: **19-605**  
Capacity: 500 ml  
6 pcs



Fresh



KTM: **19-616**  
Capacity: 500 ml  
6 pcs



Vanilla



KTM: **19-617**  
Capacity: 500 ml  
6 pcs



Lemon & Mint



KTM: **19-619**  
Capacity: 500 ml  
6 pcs



## CleanAir - AIR CONDITIONING AND VENTILATION FRESHENER



An effective refreshing and cleansing product for ventilation and air conditioning systems in vehicles. Removes unpleasant smell caused deposited dirt and moisture, adding a fresh fragrance inside the car.

OBTAINED PERMIT OF THE OFFICE FOR REGISTRATION OF MEDICAL DEVICES, MEDICINAL PRODUCTS AND BIOCIDAL PRODUCTS 6619/16.\*



Fresh

KTM: **19-092E**

Cap.: 150 ml

24 pcs



5 905694 008033



Arctic

KTM: **19-583**

Cap.: 150 ml

24 pcs



5 905694 013167



Black

KTM: **19-595**

Cap.: 150 ml

24 pcs



5 905694 015093



New Car

KTM: **19-598**

Cap.: 150 ml

24 pcs



5 905694 015970



Vanilla

KTM: **19-599**

Cap.: 150 ml

24 pcs



5 905694 015987

## MOJE AUTO NANO SILVER LINE

### NANO ANTI-FOG



Product limiting steaming up of windshields, car mirrors and other glass surfaces. When applied on glass, it greatly reduces steaming of windows, improves visibility in the rain, especially at night.

KTM: **19-521**

Capacity: 250 ml

12 pcs



5 905694 005322

### AIR CONDITIONING NANO CLEANER



OBTAINED PERMIT OF THE OFFICE FOR REGISTRATION OF MEDICAL DEVICES, MEDICINAL PRODUCTS AND BIOCIDAL PRODUCTS 6701/16.\*

The effect is permanent, not only temporary at the time of application. Effectively cleans the air conditioning system in the car. Eliminates bacteria and fungi, refreshes and protects against unpleasant odours for 3 to 5 months.

KTM: **19-535**

Capacity: 200 ml

24 pcs



5 905694 005308

### NANOSILVER ODOUR ABSORBER



A modern product used for deodourisation. Absorbs odours from the air without mixing them with its own strong fragrance. It contains active nanosilver particles. It ensures freshness and absorption of unpleasant odours for a long time.

KTM: **19-552**

Capacity: 650 ml

12 pcs



5 905694 007043

**GLASS FOAM**



Universal agent for cleaning car windshields, mirrors, headlights, lamps, turn signals. It removes organic dirt, dust, mud, fat quickly and effectively. It does not leave plumes.

KTM: **19-025**

Cap.: 400 ml

12 pcs



**GLASS CLEANER**



Universal agent for cleaning car windshields, mirrors, headlights and other glass, plastic and laminated surfaces. Cleans quickly and effectively, leaves a pleasant fragrance.

KTM: **19-049**

Cap.: 650 ml

24 pcs



**GLASS FOAM**



Universal agent for cleaning car windshields, mirrors, headlights, lamps, turn signals. It removes organic dirt, mud, grease, insects quickly and effectively. It does not leave plumes. Perfect for vertical surfaces.

KTM: **19-579**

Cap.: 650 ml

12 pcs



**GLASS CLEANER AMMONIA**



A window cleaner for all types of glass, varnished and laminated surfaces, as well as stainless steel elements. Thanks to its ammonia contents, the solution cleans glass surfaces effectively, removing even the most stubborn, dry or greasy stains.

KTM: **19-602**

Cap.: 650 ml

12 pcs



**WASHER LIQUID**

**WINDSCREEN WASHER CONCENTRATE**



Effective agent removing dirt, insects and road sediments accumulated on car windshields. Guarantees good visibility while driving. It does not damage paint or rubber gaskets.

**Forest**



KTM: **19-030**

Cap.: 250 ml

24 pcs



**Lemon**



KTM: **19-087**

Cap.: 250 ml

24 pcs



**Orange**



KTM: **19-088**

Cap.: 250 ml

24 pcs



**Apple**



KTM: **19-089**

Cap.: 250 ml

24 pcs



**WASHER LIQUID**



Washer fluid with high efficiency. Easily removes insects, dirt and road deposits from car windows and headlights. It has anti-reflective properties. Does not leave streaks. Safe for paint and rubber seals. It has a pleasant, lemon scent.

**Lemon**



KTM: **71-013**

Cap.: 5L

2 pcs





**RADIATOR SEALER**



The latest generation product sealing leaks from cooling systems. Eliminates cracks to 0.9 mm. Safe for all types of metal and aluminum radiators. It is sufficient for cooling systems with capacity of approximately 20 litres.

KTM: **19-082**  
 Capacity: 400 ml  
 12 pcs  
 5 905694 006992

**REPAIR BANDAGE**



Repair bandage resistant to water and oil. It resists temperatures to 100°C, repairs broken hoses and cables.

KTM: **19-106**  
 Dimension: 45 mm x 3 m  
 24 pcs  
 5 905694 008910

**LOCK LUBE**



Universal product, perfect for all types of locks, both in cars and houses. Prevents from blocking. Defrosts instantly, lubricates and preserves. Perfect protection against moisture.

KTM: **19-596**  
 Capacity: 100 ml  
 12 pcs  
 5 905694 015123

**SILICON SPRAY**



Silicone for lubrication of car gaskets at trunks, doors, windshields. It prevents the gaskets from sticking together, and prevents gaskets from freezing in the car door in winter.

KTM: **19-112**  
 Cap.: 200 ml  
 24 pcs  
 5 905694 010111

**SILICON SPRAY**



Silicone for lubrication of car gaskets at trunks, doors, windshields. It prevents the gaskets from sticking together, and prevents gaskets from freezing in the car door in winter.

KTM: **19-031**  
 Cap.: 400 ml  
 12 pcs  
 5 905694 006985

**LCD SCREENS CLEANER**



Product for cleaning electronic displays, touch screens, liquid crystal screens, plasma screens. Cleans electronic equipment housings, glass surfaces, mobile phone keypads, remote controls. It removes traces of hands, grease stains, dirt and dust effectively.

KTM: **19-640**  
 Cap.: 200 ml  
 12 pcs  
 5 905694 020455



# cosmetics and accessories for enthusiasts

**Moje Auto Detailer** is a modern brand including highest quality products for professional users and automotive enthusiasts. Products from the Moje Auto Detailer line is characterized by quality, simplicity of use, high efficiency and efficacy. Years of experience in the industry helped us create effective products giving you joy and satisfaction from use.



[moje-auto.pl](http://moje-auto.pl)

**X-NEON PRO  
WHEEL AND TIRE CLEANER**



NEW

X-Neon Pro is an acid-free formula for fast and effective cleaning of rims and tires. It removes tough dirt, brake dust and other contaminants, leaving rims shiny. The special formula penetrates tire crevices, removing even tough dirt. Degreases the tire surface, preparing it for dressing or coating application. Safe for steel and aluminum wheels, contains corrosion inhibitors. Ideal for quick wheel washing without risk of scratches, can be applied with a foaming machine.

KTM: **19-676**

Cap.: 750 ml

8 pcs



KTM: **19-677**

Cap.: 5 l

1 pcs



**DE-IRONIZER  
IRON REMOVER WHEEL CLEANER**



Iron Remover wheel cleaner is a rim cleaner of neutral pH. The strengthened formula reacts with strong metallic impurities to produce the "bleeding" effect.

KTM: **19-620**

Cap.: 750 ml

8 pcs



**APC  
ALL PURPOSE CLEANER**



Universal concentrate intended for perfect cleaning of any washable surface of the car. The product is safe for the cleaned surfaces, highlights their natural colour, leaves a fresh fragrance.

KTM: **19-621**

Cap.: 1 l

8 pcs



**TIRE DRESSING**



Dressing used to maintain and polish tyres. The unique formula absorbs very quickly into the tyre surface. The water-repellent properties slow down sedimentation of dirt.

KTM: **19-622**

Cap.: 500 ml

8 pcs



**NEUTRAL SNOW FOAM**



Active foam of neutral pH for safe and effective washing of car bodies., leaving snow-like effect. Owing to the modern technology, the foam is safe for all types of waxes, ceramic and quartz coatings.

KTM: **19-623**

Cap.: 1 l

8 pcs



**PLASTIC & VINYL DRESSING**



Plastic Dressing effectively removes dirt from all plastic elements in your car. It penetrates the cleaned surface and creates a protective coat. Leaves the cleaned surfaces matte.

KTM: **19-624**

Cap.: 500 ml

8 pcs



5 905694 018667

**QUICK DETAILER**



Quick Detailer is a synthetic shiny finishing wax. It protects the coating against dust deposition, adds gloss and protection of the coating immediately. It extends durability of the applied wax and ceramic coats. It is suitable for waxing aluminum rims.

KTM: **19-625**

Cap.: 750 ml

8 pcs



5 905694 018674

**LEATHER CARE  
- CLEANER & CONDITIONER**



The product is intended for cleaning and maintenance of leather upholstery. Neutral pH safe for the cleaned surface. It contains natural avocado essential oil which makes the leather soft and elastic. It restores the natural colour of leather.

KTM: **19-626**

Cap.: 500 ml

8 pcs



5 905694 018681

**LIQUID CRYSTAL COAT**



High-quality coating designed for those who wants to enhance the gloss of the car paint and ensure its long-term protection. Owing to the coat, deposited dirt will be removed easier. Application is very easy, the product can be used on all car elements, including glass, plastic, rims, metals and rubber.

KTM: **19-627**

Cap.: 500 ml

8 pcs



5 905694 020493

**INTERIOR DETAILER MATT**



Interior Detailer Matt is a product for cleaning, caring for, and protecting plastic elements inside the car, equipped with an advanced Flairosol® sprayer. The product instantly refreshes, removes minor dirt, and restores the natural appearance of the elements. Its antistatic properties repel and separate dust. It contains UV filters that protect the plastics from aging. It leaves a matte finish.

KTM: **19-653**

Cap.: 290 ml

8 pcs



5 905694 022879

**QUICK DETAILER FOR LEATHER**



One product for cleaning, caring and protection of leather surfaces. Equipped with the technologically advanced, innovative Flairosol atomiser which works in any position of the 360° and allows a unique mist of micro-droplets to evenly cover any surface (covering up to 1m2 of the surface in a single application). Can be used with any type of grain leather. Contains UV filters that protect leather against cracking and drying. Contains natural avocado oil, which makes leather soft and restores the natural color. Safe for the surface because of its neutral pH.

KTM: **19-654**

Cap.: 290 ml

8 pcs



5 905694 022886

**MICROFIBER CLOTH 600 GSM  
60X40 CM**





Fluffy and very absorbent microfiber with long and dense fibres. A good choice for running-in waxes, cleaning and refreshing the car interior. Stitched edges protect the paint against scratching.

KTM: **19-631**  
40 pcs 

**DOUBLE SIDED MICROFIBER CLOTH 840 GSM**



Fluffy and very absorbent microfiber with long and dense fibres. A good choice for running-in waxes, cleaning and refreshing the car interior. Stitched edges protect the paint against scratching.

Dimensions: 41x41 cm XL Dimensions: 60x90 cm  
KTM: **19-632** 60 pcs   
KTM: **19-633** 30 pcs 

**SEAMLESS MICROFIBER CLOTHS  
IN A BOX 30 PCS**



Set of 30 seamless microfiber cloths. A laser-cut seamless microfiber that works well for both interior cleaning and car paintwork. Safe for the surfaces being cleaned.

KTM: **19-652**  
18 pcs 

**FLUFFY DRYER MICROFIBER 450 G/M<sup>2</sup>  
60X90 CM**



**NEW**

Microfiber with very soft and fluffy bristles is ideal for drying the bodywork. The fine texture of the microfiber and the hemmed edges provide protection against scratching the paintwork. Can also be used for wiping quick detailers and for waterless washing of the car body. It is recommended to wash the microfiber at up to 40°C without softeners or bleach. Do not dry on radiator sand do not iron. Dry on delicate mode.

KTM: **19-662**  
40 pcs 

**ALL PURPOSE TOWEL  
BLACK LASER CUT MICROFIBER 370 G/M<sup>2</sup>  
40X40 CM  
LASER CUT**



**NEW**

Seamless laser-cut microfiber with very thick and short fibers is perfect for all purpose car cleaning works. This microfiber can be used to buff out waxes, coatings, quick detailers as well as to clean and maintain textile and leather upholstery and interior elements. The microfiber can also be used to clean windows and lcd screens. High-quality fibers and laser-cut edges provide protection against scratching of all types of surfaces. It is recommended to wash the microfiber at up to 40°C without softeners or bleach. Do not dry on radiators or iron. Dry on delicate mode.

KTM: **19-663**  
48 pcs 

**WAFFLE DIAMOND GLASS MICROFIBER  
360 G/M<sup>2</sup>  
40X40 CM  
GREY**



**NEW**

Microfiber with a waffle structure for cleaning glass surfaces. Leaves no fibers or streaks when working on the surface, making cleaning glass and mirrors very easy and less time-consuming. For dry and wet use. It is recommended to wash the microfiber at up to 40°C without softeners or bleach and with similar colours. Do not dry on radiators and do not iron. Dry on delicate mode.

KTM: **19-664**  
50 pcs 

**FLUFFY DRYER 800 MICROFIBER 800 G/M<sup>2</sup>  
60X90 CM**

**NEW**



Fluffy and highly absorbent microfiber with long and dense fibers. Ideal for drying the bodywork. Very effectively collects the excess of water from the paint surface, without leaving any streaks. Allows quick drying of the whole car without the need for constant wringing out of the towel. Hemmed edges ensure safety against scratching the paintwork. It is recommended to wash the microfiber at up to 40°C without using softeners or bleach. Do not dry on radiators or in tumble dryers.

KTM: **19-665**  
20 pcs 

**PU MICRO MAX PRO MICROFIBER 245 G/M<sup>2</sup>  
49X43 CM**

**NEW**



Microfiber for cleaning and polishing glass and lacquered surfaces. It quickly and easily removes grease and stubborn dirt. By combining regular microfiber with polyurethane, the microfiber is highly absorbent, ensuring effective cleaning without streaks. Polyurethane creates foam-like pores that trap dust and dirt inside the microfiber. The microfiber does not separate, leaves no fibers on the cleaned surface, and effectively dries and polishes the surface. Suitable for both dry and wet use, even without detergents. Laser cut. It withstands washing at 90°C, releasing dirt and bacteria. It is recommended to wash the microfiber at temperatures up to 90°C without using fabric softeners and bleaches. Do not dry on radiators.

KTM: **19-666**  
50 pcs 

**KING DRYER TWISTED TOWEL MICROFIBER  
1200 G/M<sup>2</sup>**

**NEW**



**XL  
VERSION**

Revolutionary microfiber made with a unique TWISTED PILE fiber weave. Designed primarily to dry lacquer quickly and effectively without leaving streaks. The TWISTED PILE is characterised by excellent water absorption and rapid drying of the microfibers themselves. The twisted bristles drying of the microfibers themselves. The fine, high-quality fibers are scratch-free and safe for all types of paintwork. Thanks to the length of the fibers the microfiber glides easily over the varnish. It is recommended to wash the microfiber at up to 40°C without softeners or bleach. Do not dry on radiators and do not iron. Dry on delicate mode.

Dimensions: 40x40 cm  
KTM: **19-667**  
50 pcs 

XL, Dimensions: 60x90 cm  
KTM: **19-668**  
20 pcs 

**LEATHER WHITE MICROFIBER 310 G/M<sup>2</sup>  
40X40 CM**

**NEW**



Special microfiber for cleaning and caring for the leather surfaces. Does not dye the cleaned surface so we can use stronger cleaning agents. The stiff and very short fibers are effective in cleaning. Perfect for working on seams, pores and folds in the leather. For dry and wet use. It is recommended to wash the microfiber at up to 40°C without softeners or bleach and in similar colours. Do not dry on radiators. Dry on delicate mode.

KTM: **19-669**  
50 pcs 

**DOUBLE SIDED TWISTED TOWEL MICROFIBER 580 G/M<sup>2</sup>**

**NEW**

**XL  
VERSION**



Revolutionary microfiber made from a unique TWISTED PILE fibers. The fluffy side is used for drying paintwork, the smooth side is ideal for cleaning windows or interiors. The twisted pile is characterized by excellent water absorption and rapid drying of the microfibers themselves. Therefore, the drying process itself is faster compared to standard microfibers. The fine, high-quality fibers leave no scratches and are safe for all types of paintwork. The fine hemming increases the life of the microfiber, but also does not cause additional scratches. Thanks to the appropriate length of the fibers the microfiber glides easily over the varnish. It is recommended to wash the microfiber at up to 40°C without softeners or bleach. Do not dry on radiators and do not iron. Dry on delicate mode.

Dimensions: 53x47 cm  
KTM: **19-670**  
40 pcs 

XL, Dimensions: 60x90 cm  
KTM: **19-671**  
30 pcs 

## CAR WASH GLOVE



The mitt is designed for washing the car body. It perfectly adapts to the surface so you can clean all nooks. It is made of soft fibres, prevents scratching while washing. It does not slip from the hand.

KTM: **19-629**  
 40 pcs 5 905694 020516

## WASH MITT ULTRA SOFT



The most delicate glove for washing cars. Medium length bristles. Extremely durable, delicate and super soft. Comfortable washing thanks to the large surface area of the glove. It removes dirt very well and can be used not only on the outside but also for cleaning the interior.

KTM: **19-638**  
 48 pcs 5 905694 022220

## WASH MITT WITH WOOL & MESH



Polymer-coated glove for cleaning paint with clay. Removes insect, resin, tar, glue and asphalt residues and other stubborn dirt. The high-quality polymer does not damage the lacquer. Easier and quicker to use compared to traditional clay - always ready to use. Make sure that the surface to be clayed is always wet when working.

KTM: **19-639**  
 48 pcs 5 905694 022237

# APPLICATORS | CLEANING AND WASHING BRUSHES

## CLAY SPONGE



Effective decontamination sponge with a polymer layer replacing a traditional clay bar. Easily removes tar, resin, asphalt, bug remains and other persistent residues.

KTM: **19-637**  
 50 pcs 5 905694 022213

## CAR WAX APPLICATOR



Sponge designed for even application of waxes and products that require precise application. It can be used on painted, rubber, plastic, vinyl and leather surfaces. The soft foam structure does not scratch the coating.

KTM: **19-630**  
 240 pcs 5 905694 020523

## TIRE CAR APPLICATOR



Professional tyre applicator with cover. The applicator adapts to the surface of the tyre, so you can easily and precisely spread the product on the tyre. The ergonomic cover protects hands from dirt.

KTM: **19-635**  
 50 pcs 5 905694 022190

**DRILL BRUSH SET  
3 PCS**



A set of brushes for cleaning very dirty places fixed to a screwdriver or drill. Three different sizes and shapes will help cleaning places that are easy and hard to reach. The brushes can be used for cleaning upholstery, mats and carpets. The brushes are made of medium hardness nylon.

KTM: **19-628**  
18 pcs 5 905694 020509

**RIM BRUSH PRO**



The brush is designed for all types of rims. It can be bent freely to clean the entire surface of the rim. Its length allows for reaching the rear part of the rim. Delicate, nylon bristles are resistant to strong rim cleaners, and do not cause scratching. The brush removes dirt effectively. The durable handle with rubber cover is going to protect the rim and your hand against scratches.

KTM: **19-634**  
12 pcs 5 905694 020561

**ULTIMATE  
WHEEL BRUSH  
SIZE S - 26 CM**



High quality brush made of very soft and dense weave of polypropylene bristle resistant to chemicals. The brush has been designed mainly for cleaning all types of car wheels, but it is also suitable for cleaning the interior, engine compartment or wheel arch recesses. The brush can be bent as desired to reach all corners.

KTM: **19-647**  
100 pcs 5 905694 022251

**DETAILING BRUSHES AND ACCESSORIES**

**DETAILING BRUSH  
ULTRA SOFT**



A detailing brush designed to clean the most demanding surfaces on the outside and inside of the car. Made of very fine synthetic bristles. Designed for cleaning internal scratch-prone surfaces such as LCD screens, delicate plastics (e.g., piano black). For dry and wet working.

KTM: **19-649**  
50 pcs 5 905694 022275

**DETAILING BRUSH  
5 PCS / SET**



A set of five detailing brushes. Designed for dry and wet cleaning of hard-to-reach areas. The ergonomic handle lies well in the hand. High-quality bristles will not scratch the surface. Plastic covers protect against accidental scratches. Five sizes and lengths suitable for different jobs.

KTM: **19-650**  
50 pcs 5 905694 022282

**CLEANING SWABS KIT  
4 PCS / SET**



Sticks for cleaning and spreading cleaning preparations. The sticks are finished with an abrasion-resistant sponge. You can use the sticks to reach hard-to-reach places such as air vents, spaces between seats and other nooks and crannies inside and outside. The sticks can also be used for electronic work, camera cleaning and other precision work.

KTM: **19-651**  
100 pcs 5 905694 022299



## DETAILING BRUSH SIZE 8 DIAMETER 16 MM

**NEW**



8 mm x 16 mm

The brush designed for dry and wet cleaning of hard-to-reach areas. The high-quality bristles are suitable for cleaning rims, recesses, door sides or the engine compartment. The bristles are made of a synthetic material that is resistant even to very strong chemicals. The plastic cover protects against accidental scratching of the surrounding surfaces. The ergonomic handle fits well in the hand. Do not use on very delicate surfaces subject to scratching, e.g. piano black.

KTM: **19-657**  
50 pcs



## DETAILING BRUSH SIZE 12 DIAMETER 25 MM

**NEW**



12 mm x 25 mm

The brush designed for dry and wet cleaning of hard-to-reach areas. The high-quality bristles are suitable for cleaning rims, recesses, door sides or the engine compartment. The bristles are made of a synthetic material that is resistant even to very strong chemicals. The plastic cover protects against accidental scratching of the surrounding surfaces. The ergonomic handle fits well in the hand. Do not use on very delicate surfaces subject to scratching, e.g. piano black.

KTM: **19-658**  
50 pcs



## DETAILING BRUSH SIZE 16 DIAMETER 35 MM

**NEW**



16 mm x 35 mm

The brush designed for dry and wet cleaning of hard-to-reach areas. The high-quality bristles are suitable for cleaning rims, recesses, door sides or the engine compartment. The bristles are made of a synthetic material that is resistant even to very strong chemicals. The plastic cover protects against accidental scratching of the surrounding surfaces. The ergonomic handle fits well in the hand. Do not use on very delicate surfaces subject to scratching, e.g. piano black.

KTM: **19-659**  
50 pcs



## DETAILING BRUSH SIZE 18 DIAMETER 40 MM

**NEW**



18 mm x 40 mm

The brush designed for dry and wet cleaning of hard-to-reach areas. The high-quality bristles are suitable for cleaning rims, recesses, door sides or the engine compartment. The bristles are made of a synthetic material that is resistant even to very strong chemicals. The plastic cover protects against accidental scratching of the surrounding surfaces. The ergonomic handle fits well in the hand. Do not use on very delicate surfaces subject to scratching, e.g. piano black.

KTM: **19-660**  
50 pcs





# winter offer

The **AMTRA** offer of winter cosmetics includes winter windshield wiper fluid and windscreen defrosters. The offer also includes: a lock de-icer, specialist preparations for car seal maintenance, and products boosting engine startup at low temperatures.



[moje-auto.pl](http://moje-auto.pl)

## DE-ICER

**MOJE AUTO**



### GLASS DE-ICER

Removes ice and snow from exterior windshields. It works instantly (in 5 seconds). Effective at temperatures to -50°C. Leaves no streaks. It can be used to defrost locks.

KTM: **25-011**  
 Cap.: 650 ml  
 12 pcs  
  
 5 905694 001935

## WINTER WASHER FLUIDS

### WASHER FLUID -20°C



Removes frost, salt, slush and other dirt. Prevents the spray nozzles from freezing. Ensures protection up to -20°C. It has a pleasant sea scent.

KTM: **71-006**  
 Capacity: 5 L  
  
 108 pcs 5 905694 001904

### WASHER FLUID -15°C



Removes frost, salt, slush and other dirt. Prevents the spray nozzles from freezing. Ensures protection up to -15°C. It has a pleasant sea scent.

KTM: **71-019**  
 Capacity: 5 L  
  
 108 pcs 5 905694 022848

### WASHER FLUID -80°C



Removes frost, salt, slush and other dirt. Prevents the spray nozzles from freezing. Ensures protection up to -80°C. It has a pleasant sea scent.

KTM: **25-025**  
 Capacity: 1 L  
  
 6 pcs 5 905694 017417

## OTHER WINTER PRODUCTS

### DIESEL DEPRESSANT



Lowers the melting point of diesel fuel. It prevents the formation of paraffin crystals and thickening of the oil at low temperatures. It is sufficient for 500/1000 L of diesel fuel. Improves ignition at low temperature. Removes deposits and carbon deposits from the fuel system. Effective at temperatures up to -40°C.

KTM: **25-014**  
 Cap.: 500 ml  
  
 24 pcs 5 905694 001997

### LOCK DE-ICER



It defrosts, lubricates and preserves. It works instantly. It prevents re-freezing. It has anti-corrosive properties.

KTM: **25-013**  
 Cap.: 50 ml  
  
 20 pcs 5 905694 001911



# radigard

## car radiator fluids

**RADIGARD** radiator fluids are a new addition to the MA Professional product line. Available in two colors – green and red. Radigard fluids come in both ready-to-use and concentrate forms. They are compatible with any color of radiator fluid. These fluids provide excellent protection for the cooling system against corrosion and are suitable for all types of radiators and vehicles. They ensure the engine operates at an optimal temperature. Radigard fluids complement the existing range of MA Professional radiator fluids, which are highly valued by professional users in automotive services and workshops.



[ma-pro.com.pl](http://ma-pro.com.pl)

## RADIATOR COOLANT GREEN



KTM: **61-001**

Cap.: 1L

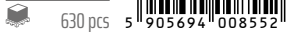

630 pcs

KTM: **61-002**

Cap.: 5L



90 pcs

## RADIATOR COOLANT RED G12



KTM: **61-110**

Cap.: 1L

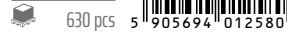

630 pcs

KTM: **61-111**

Cap.: 5L

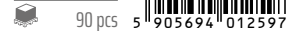

90 pcs

## RADIATOR COOLANT CONCENTRATE GREEN



KTM: **61-003**

Cap.: 1L



630 pcs

KTM: **61-004**

Cap.: 5L



90 pcs

## RADIATOR COOLANT CONCENTRATE RED G12



KTM: **61-112**

Cap.: 1L



630 pcs

KTM: **61-113**

Cap.: 5L



90 pcs

## Radiator Coolant

MA Professional Radiator Coolant is a modern product for car radiators - ready to use and concentrated, with high performance parameters. It can be mixed with other radiator liquids based on ethylene glycol regardless of the color.

- Guarantees optimal working temperature in any conditions - unique composition protects the engine from overheating in the summer and prevents the fluid from freezing in the system in the winter.

- Excellent performance up to max 35°C - "ready to use" fluid (and the concentrate - up to max -64°C, depending on the dilution).
- For all types of radiators - the product is intended for use in radiators made of aluminum and other metal alloys.
- Full engine protection - a special package of anti-corrosive and refining additives prevents the cooling system from corroding, thus guaranteeing the long and effective function of the engine.
- Available in: green, blue and red G12.

**RADIATOR COOLANT  
BLUE**



KTM: **61-102**  
Cap.: 5 L  
108 pcs



KTM: **61-103**  
Cap.: 1 L  
450 pcs



**RADIATOR COOLANT CONCENTRATE  
BLUE**



KTM: **61-109**  
Cap.: 5 L  
108 pcs



KTM: **61-106**  
Cap.: 1 L  
450 pcs



**RADIATOR COOLANT  
RED G12**



KTM: **61-104**  
Cap.: 5 L  
108 pcs



KTM: **61-105**  
Cap.: 1 L  
450 pcs



**RADIATOR COOLANT CONCENTRATE  
RED G12**



KTM: **61-108**  
Cap.: 5 L  
108 pcs



KTM: **61-107**  
Cap.: 1 L  
450 pcs



## RADIATOR COOLANT GREEN



KTM: **61-006**

Cap.: 20 kg

24 pcs



5 905694 009405

## RADIATOR COOLANT RED G12



KTM: **61-010**

Cap.: 20 kg

24 pcs



5 905694 016144

## RADIATOR COOLANT BLUE



KTM: **61-011**

Cap.: 20 kg

24 pcs



5 905694 016151

## RADIATOR COOLANT CONCENTRATE GREEN



KTM: **61-012**

Cap.: 20 kg

24 pcs



5 905694 016496

## RADIATOR COOLANT CONCENTRATE RED G12



KTM: **61-013**

Cap.: 20 kg

24 pcs



5 905694 016502

## RADIATOR COOLANT CONCENTRATE BLUE



KTM: **61-014**

Cap.: 20 kg

24 pcs



5 905694 016519



moje-auto.pl

# car accessories

Moje Auto Virage are car accessories - the next brand in the Moje Auto product family. The brand offers its users the sense of safety, comfort and order when traveling by car. The complete offer includes about 120 products - divided into 6 categories:

- bulbs
- wipers
- safety
- season
- tools
- accessories



## CAR BULBS

Moje Auto Virage CAR-LUM bulbs are designed for use in headlights of cars, motorbikes and other vehicles in traffic. Each bulb is tested electronically before packing.

### Properties:

- +30% in the light coverage range
- +20% in light intensity
- +20% in lighting duration

## HALOGEN LAMPS - EUROPEAN HOMOLOGATION, HIGH BEAM, LOW BEAM, FOG LAMPS

<p><b>HALOGEN BULB 12V H1 55W</b></p>  <p>KTM: <b>91-001</b> 10 pcs</p> <p>5 905694 009597</p>	<p><b>HALOGEN BULB 12V H3 55W</b></p>  <p>KTM: <b>91-002</b> 12 pcs</p> <p>5 905694 009603</p>	<p><b>HALOGEN BULB 12V H4 60/55W</b></p>  <p>KTM: <b>91-003</b> 12 pcs</p> <p>5 905694 009610</p>	<p><b>HALOGEN BULB 12V H7 55W</b></p>  <p>KTM: <b>91-004</b> 10 pcs</p> <p>5 905694 009627</p>
---	---	---	---

## AUXILIARY LAMPS - EUROPEAN HOMOLOGATION

<p><b>BULB 12V W5W 5W T10 (2PACK)</b></p>  <p>KTM: <b>91-005</b> 10 pcs</p> <p>5 905694 009634</p>	<p><b>BULB 12V P21W BA15S CLEAR (2PACK)</b></p>  <p>KTM: <b>91-006</b> 12 pcs</p> <p>5 905694 009641</p>	<p><b>BULB 12V PY21W BA15S AMBER (2PACK)</b></p>  <p>KTM: <b>91-007</b> 10 pcs</p> <p>5 905694 009658</p>	<p><b>BULB 12V P21/5W BAY15D CLEAR (2PACK)</b></p>  <p>KTM: <b>91-008</b> 10 pcs</p> <p>5 905694 009665</p>
---	---	---	--

## SPARE LAMP KITS WITH Z H4 OR H7

### BULB SET 12V Z H4 - 8 PCS

#### LIST:

- H4 60/55W P43t
- P21W
- P21/5W
- R5W
- W5W
- fuse 10A
- fuse 15A
- fuse 20A



KTM: **91-013**  
12 pcs



### BULB SET 12V Z H7 - 8 PCS

#### LIST:

- H7 55W PX26d
- P21W
- P21/5W
- R5W
- W5W
- fuse 10A
- fuse 15A
- fuse 20A



KTM: **91-014**  
12 pcs



# Moje Auto VIRAGE HYBRID Series Hybrid wiper + 9 adapters

Hybrid car wipers are low-profile elements with the blade fully covered and integrated with the arm. Most of all, hybrid wipers have the advantages of both conventional and frameless wipers. Owing to them, the driver can enjoy quiet operation, excellent

pressure and very low losses caused by the rush of air while driving.

## HYBRID Series:

- fit 95% of car models
- even pressure, aerodynamic shape
- teflon-coated rubber
- 9 adapters



### HYBRID CAR WIPER - CARTON BOX

KTM: **92-H14**  
350 mm - 14"



KTM: **92-H15**  
375 mm - 15"



KTM: **92-H16**  
400 mm - 16"



KTM: **92-H17**  
425 mm - 17"



KTM: **92-H18**  
450 mm - 18"



KTM: **92-H19**  
475 mm - 19"



KTM: **92-H20**  
500 mm - 20"



KTM: **92-H21**  
525 mm - 21"



KTM: **92-H22**  
550 mm - 22"



KTM: **92-H23**  
575 mm - 23"



KTM: **92-H24**  
600 mm - 24"



KTM: **92-H26**  
650 mm - 26"



KTM: **92-H28**  
700 mm - 28"



10 pcs

### HYBRID CAR WIPER - BLISTER PACK

KTM: **92-114N**  
350 mm - 14"



KTM: **92-115N**  
375 mm - 15"



KTM: **92-116N**  
400 mm - 16"



KTM: **92-117N**  
425 mm - 17"



KTM: **92-118N**  
450 mm - 18"



KTM: **92-119N**  
475 mm - 19"



KTM: **92-120N**  
500 mm - 20"



KTM: **92-121N**  
525 mm - 21"



KTM: **92-122N**  
550 mm - 22"



KTM: **92-124N**  
600 mm - 24"



KTM: **92-126N**  
650 mm - 26"



KTM: **92-128N**  
700 mm - 28"



10 pcs

## HYBRID WIPER BLADES "U" TYPE

### Moje Auto VIRAGE HYBRID U Series Hybrid windshield wiper with a „U” adapter

Hybrid car wipers are low-profile elements with the blade fully covered and integrated with the arm. Most of all, hybrid wipers have the advantages of both conventional and frameless wipers. Owing to them, the driver

can enjoy quiet operation, excellent pressure and very low losses caused by the rush of air while driving.

#### HYBRID U Series:

- even pressure
- aerodynamic shape
- teflon-coated rubber



KTM: **92-HU14**  
350 mm - 14"



5 905694 018742

#### HYBRID CAR WIPER - „U” TYPE

KTM: **92-HU15**  
375mm - 15"



5 905694 018759

KTM: **92-HU16**  
400mm - 16"



5 905694 018766

KTM: **92-HU17**  
425mm - 17"



5 905694 018773

KTM: **92-HU18**  
450mm - 18"



5 905694 018780

KTM: **92-HU19**  
475mm - 19"



5 905694 018797

KTM: **92-HU20**  
500mm - 20"



5 905694 018803

KTM: **92-HU21**  
525mm - 21"



5 905694 018810

KTM: **92-HU22**  
550mm - 22"



5 905694 018827

KTM: **92-HU23**  
575mm - 23"



5 905694 018834

KTM: **92-HU24**  
600mm - 24"



5 905694 018841

KTM: **92-HU26**  
650mm - 26"



5 905694 018858

KTM: **92-HU28**  
700mm - 28"



5 905694 018865

10 pcs

## Moje Auto VIRAGE Series of **FRAMED WIPERS** An universal, framed wiper

High-quality universal conventional wiper blade. Fits both passenger cars and delivery trucks. The wiper blade is made of natural rubber. The frame is made of thick galvanized steel covered with a layer protecting from UV radiation and corrosion. Wipers ensuring good visibility all year round. The wiper works along its entire length in both directions owing to the metal joints ensuring excellent pressure

re against the windshield. When they are longer than 53 cm, we apply as many as 8 pressure points. Fifteen different lengths from 27 cm up to 65 cm! The features of the universal, framed wiper series are: excellent visibility all year long, resistance to corrosion and UV light, even pressure at the entire length, no smudges in both directions.

### UNIVERSAL, FRAMED WIPER:

- excellent visibility all year long,
- resistance to corrosion and UV light,
- even pressure at the entire length,
- no smudges in both directions



### CONVENTIONAL CAR WIPER - UNIVERSAL

KTM: **92-511**  
275 mm - 11"



5 905694 019572

KTM: **92-512**  
300 mm - 12"



5 905694 019583

KTM: **92-513**  
325 mm - 13"



5 905694 019596

KTM: **92-514**  
350 mm - 14"



5 905694 019602

KTM: **92-515**  
375 mm - 15"



5 905694 019619

KTM: **92-516**  
400 mm - 16"



5 905694 019626

KTM: **92-517**  
425 mm - 17"



5 905694 019633

KTM: **92-518**  
450 mm - 18"



5 905694 019640

KTM: **92-519**  
475 mm - 19"



5 905694 019657

KTM: **92-520**  
500 mm - 20"



5 905694 019664

KTM: **92-521**  
525 mm - 21"



5 905694 019671

KTM: **92-522**  
550 mm - 22"



5 905694 019688

KTM: **92-523**  
575 mm - 23"



5 905694 019695

KTM: **92-524**  
600 mm - 24"



5 905694 019701

KTM: **92-526**  
650 mm - 26"



5 905694 019718

## PROFILED WIPER BLADES - BASIC

### Moje Auto VIRAGE BASIC Series Profiled windshield wiper with a „U” adapter.

Perfect for the whole season and various weather conditions. Designed to wipe water off from windshields of passenger cars, delivery vans, trucks. Owing to the universal adapter - it fits most cars (approx. 75%). Available in 12 sizes. Graphite rubber. High performance. Long service life. Easy and fast

assembly - instructions on the packaging. The features of the basic series are: plastic shield of the adapter socket, rubber spoiler applied in parts, ending with plastic caps, attractive price.

#### BASIC Series:

- plastic shield of the adapter socket
- rubber spoiler applied in parts
- ending with plastic caps, attractive price

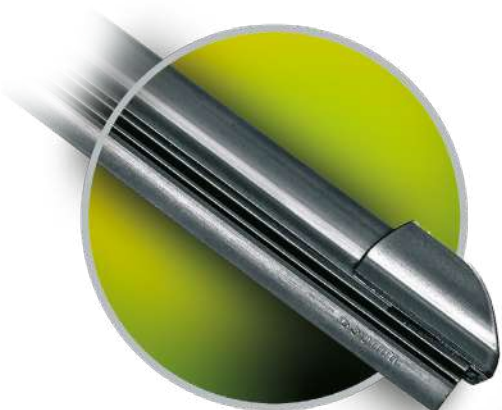

#### PROFILED CAR WIPER - „U” TYPE

KTM: **92-013B**

350 mm - 14"



5 905694 011644

KTM: **92-014B**

375 mm - 15"



5 905694 011651

KTM: **92-015B**

400 mm - 16"



5 905694 011668

KTM: **92-016B**

425 mm - 17"



5 905694 011675

KTM: **92-017B**

450 mm - 18"



5 905694 011682

KTM: **92-018B**

475 mm - 19"



5 905694 011699

KTM: **92-019B**

500 mm - 20"



5 905694 011705

KTM: **92-020B**

525 mm - 21"



5 905694 011712

KTM: **92-021B**

550 mm - 22"



5 905694 011729

KTM: **92-022B**

600 mm - 24"



5 905694 011736

KTM: **92-023B**

650 mm - 26"



5 905694 011743

KTM: **92-024B**

700 mm - 28"



5 905694 011750

**PRESSURE GAUGE FOR PASSENGER CARS RANGE 0-5,5 BARS**



Intended for measuring pressure in car, motorcycle, scooter, trailer, bicycle wheels, etc. Robust and accurate, with a dial and a button to reset the result. Maximum pressure measurement 5,5 bar/75 psi.

KTM: **93-009**  
24 pcs  
5 905694 010371

**PRESSURE GAUGE FOR PASSENGER CARS RANGE 0-3 BARS**



A robust and accurate pressure gauge with a dial. Maximum pressure measurement up to 3 bars. Necessary equipment of every car.

KTM: **93-010**  
10 pcs  
5 905694 010388

**CAR COMPRESSOR 12V 250 PSI - 18 BAR**



For inflating car and bicycle tyres. The kit includes nozzles for inflating sports and recreational equipment. Equipped with power supply cable with a 12 V cigarette lighter plug. Pressure hose with a lockable valve nozzle.

KTM: **93-015**  
20 pcs  
5 905694 010432

**BATTERY CHARGER 6V/12V 6A / 4A**



For charging lead-acid batteries used in cars, motorcycles, motor boats and similar vehicles. It should not be used for charging nickel cadmium batteries or other types of batteries.

6V/12V 6A  
KTM: **93-038**  
8 pcs  
5 905694 016670

6V/12V 4A  
KTM: **93-039**  
8 pcs  
5 905694 016700

**BATTERY TERMINALS 2 PCS PLUS AND MINUS**



Clamps for car batteries 6, 12 and 24V. For cable installation without soldering.

KTM: **93-017**  
10 pcs  
5 905694 010456

**BRASS CLIP BATTERY**



Universal brass clamps. Easy installation. A set of clamps for cable installation without soldering. Fits all 6, 12 and 24V batteries. Set of 2 pcs. Positive and negative battery clamp.

KTM: **93-003**  
12 pcs  
5 905694 010319

CAR ACCESSORIES

LUGGAGE FITTING RUBBER TAPE



They securely protect luggage against shifting. Easy assembly. Made in EU.

Rubber Tape TUV  
60 cm 2 pcs

KTM: **93-006**  
75 pcs



Rubber Tape TUV  
80 cm 2 pcs

KTM: **93-004**  
65 pcs



Rubber Tape TUV  
100 cm 2 pcs

KTM: **93-005**  
55 pcs



RUBBER 8-ARM EXPANDER 80 CM



Used for securing luggage on car roof racks, trailers. Its length increases twice. Each tip of the expander has a metal hook.

KTM: **93-026**  
48 pcs



SET OF BLACK CAR MATS- 4 PCS



For passenger cars. All-year. Its custom design fits all cars. Easy cleaning. Guaranteed durable colour of mats. Adjustment to any passenger car model with scissors. Each kit contains two front mats and two rear mats.

KTM: **93-011**  
6 pcs



LICENCE PLATE FRAMES



Intended for fitting car licence plates. All of it is made of high-impact polystyrene. Single-use product.

License plate frame  
- black

KTM: **93-001**  
50 pcs



License plate frame  
- with letters

KTM: **93-002**  
50 pcs



License plate frame  
- matt silver

KTM: **93-035**  
10 pcs



License plate frame  
- shiny chrome

KTM: **93-036**  
10 pcs



TRUNK ORGANISER WITH VELCRO



A perfect bag for keeping the trunk in order. Easy fitting with Velcro fasteners. It has additional side pockets. Dimension 49 x 23 x 17 cm.

KTM: **93-023**  
30 pcs



**AIR VENT PHONE  
HOLDER SMART FIT**



Universal phone holder attached to the air vent. The Smart Fit system allows for quick and easy installation of the phone in the handle - with just one click!

KTM: **93-040**  
100 pcs



**AIR VENT MAGNETIC  
PHONE HOLDER**



The magnetic phone holder allows for quick fitting the device in the holder. The kit includes 2 metal plates: with adhesive tape and to be placed under the case.

KTM: **93-041**  
25 pcs



**SMART FIT PHONE HOLDER**



Suitable for devices with a max. diagonal 6 in. The "Smart Fit" system allows for attaching the phone quickly with just one click. For fitting both on windshields and dashboards. The non-slip inner surface protects the phone against shifting.

KTM: **93-037**  
10 pcs



**CAR UNIVERSAL GPS, IPHONE,  
PHONE, PDA HOLDER**



A strong suction cup allows for attaching the holder to any material. Convenient and universal use. Up to 10.5 cm - width of the devices mounted. Swivel head for installation in convenient position. Comfortable use. Elegant and fashionable finish.

KTM: **93-021**  
60 pcs





CAR ACCESSORIES

12/24V TEE WITH CABLE  
WITH USB SOCKET



It allows for connecting four electronic devices in one 12/24V cigarette lighter socket. It has a USB 5VDC/500mA (max) socket outlet. A 70 cm long duct. Dimensions of the device: 11.5 x 3.2 x 5. The maximum power of connected devices to 120W.

KTM: **93-019**  
10 pcs



5 905694 010470

CAR CHARGER 2 X USB



Mobile phone car charger. Suitable for charging smartphones and tablets. It has 2 USB sockets. Illuminated while charging.

KTM: **93-100**  
50 pcs



5 905694 017493

PHONE CABLE MICRO USB



Universal Micro USB cable. Length: 120 cm.

KTM: **93-102**  
100 pcs



5 905694 020288

PHONE CABLE MICRO USB



Universal Type C cable. Length: 120 cm.

KTM: **93-103**  
100 pcs



5 905694 020295

PHONE CABLE IPHONE



Universal iPhone cable. Length: 120 cm.

KTM: **93-104**  
100 pcs



5 905694 020301

**POWDER FIRE EXTINGUISHER 1 KG  
GB-1BC**



Easy and ergonomic use. Quick and effective in extinguishing. Cost-effective in maintenance and service. The valve's construction allows for temporary interruption of extinguishing.

KTM: **98-011**  
6 pcs  
5 905694 010579

**POWDER FIRE EXTINGUISHER 2 KG  
GB-2X-ABC/PM**



Easy and ergonomic use. Quick and effective in extinguishing. Cost-effective in maintenance and service. The shut-off valve downstream the pressure gauge facilitates checking the extinguisher. Refillable.

KTM: **98-012**  
4 pcs  
5 905694 010586

**POWDER FIRE EXTINGUISHER 6 KG  
GB-6X-ABC**



Easy and ergonomic use. Quick and effective in extinguishing. Cost-effective in maintenance and service. The shut-off valve downstream the pressure gauge facilitates checking the extinguisher. Refillable.

KTM: **98-013**  
1 pcs  
5 905694 010593

**FIRST-AID KIT**



Elementary equipment with first aid casts. All products in the first-aid kit are CE marked and are manufactured in accordance with EU standards. "First aid in case of emergency" instructions.

KTM: **94-004**  
10 pcs  
5 905694 010609

**FIRST-AID KIT DIN 13164**



A car first-aid kit packet with adhesive tape for attaching the first-aid kit to the upholstery. The kit meets the requirements of EU standards. Composition compliant with DIN 13164. "First aid in case of emergency" instructions.

KTM: **94-006**  
10 pcs  
5 905694 010623

**WARNING TRIANGLE**



The triangle has European approval. Three foldable arms - the arm is approx. 43 cm long. The base - a folding stand with four supports, very quick folding and unfolding of the rack. Warning triangle in plastic box - dimensions of the box: 44 x 5 x 3 cm.

KTM: **94-009**  
12 pcs  
5 905694 010654

CAR ACCESSORIES - SAFETY

WARNING VEST



Gives maximum comfort, signals the presence of the user on the road in hazardous situations regardless of weather conditions, in the dark, when vehicle headlights are the only source of light on the road, and in difficult conditions. Certified reflective tape. Orange colour.

Warning Vest L/XL

KTM: **94-031**  
 10 pcs 5 905694 015543

Warning Vest 3XL

KTM: **94-040**  
 10 pcs 5 905694 020837



Warning Vest L/XL

KTM: **94-039**  
 10 pcs 5 905694 020820

DISPOSABLE ALCOHOL TESTER



CERTIFIED PS 87/2013

The product is intended for single use. It is used for independent testing of the alcohol content in exhaled air. The alkotest is used to detect 0.2‰ (per mille) alcohol blood level, that is 0.1 mg/L of alcohol in the exhaled air. Certified.

KTM: **94-020**  
 30 pcs 5 905694 010760

CAR TOW ROPE 1500 KG + 2 HOOKS PIMOT



The tow rope is intended for towing cars on roads under normal conditions and with a total weight in compliance with the product marking. Compliant with the applicable Technical Conditions.

KTM: **94-032**  
 20 pcs 5 905694 015765

CAR TOW ROPE 2500 KG + 2 HOOKS PIMOT



The tow rope is intended for towing cars on roads under normal conditions and with a total weight in compliance with the product marking. Compliant with the applicable Technical Conditions.

KTM: **94-033**  
 16 pcs 5 905694 015772

CAR TOW ROPE 3500 KG + 2 HOOKS PIMOT



The tow rope is intended for towing passenger cars and delivery trucks. Easy and safe method of installation with hooks. The maximum tractive force is 3.500 kg, the minimum length 4 m. Compliant with the applicable Technical Conditions.

KTM: **94-034**  
 12 pcs 5 905694 015789

**CAR FUSES UNI  
SET 10 PCS**



Designed for cars with 12V and 24V installation. Indispensable in any car. Values expressed in amperes. Used in most European cars. Preserved standard of colour markings.

KTM: **94-015**  
10 pcs  
5 905694 010715

**CAR FUSES MINI  
SET 10 PCS**



Designed for cars with 12V and 24V installation. Indispensable in any car. Values expressed in amperes. Used in most European and Japanese cars. Preserved standard of colour markings.

KTM: **94-016**  
10 pcs  
5 905694 010722

**CYLINDRIC FUSES  
SET 10 PCS**



Values expressed in amperes. Suitable for some passenger cars, delivery trucks and agricultural machinery.

KTM: **94-038**  
10 pcs  
5 905694 016632

**CAR FUSES UNI  
100 PCS**



Designed for cars with 12V and 24V installation. Indispensable in any car. Values expressed in amperes. Used in most European cars. Preserved standard of colour markings.

5A	7,5A	10A	15A	20A	25A	30A
KTM: <b>94-050</b>	KTM: <b>94-051</b>	KTM: <b>94-052</b>	KTM: <b>94-053</b>	KTM: <b>94-054</b>	KTM: <b>94-055</b>	KTM: <b>94-056</b>
10 pcs	10 pcs	10 pcs	10 pcs	10 pcs	10 pcs	10 pcs
5 905694 023098	5 905694 023104	5 905694 023111	5 905694 023128	5 905694 023135	5 905694 023142	5 905694 023159

**CAR FUSES MINI  
100 PCS**



Designed for cars with 12V and 24V installation. Indispensable in any car. Values expressed in amperes. Used in most European cars. Preserved standard of colour markings.

5A	7,5A	10A	15A	20A	25A	30A
KTM: <b>94-057</b>	KTM: <b>94-058</b>	KTM: <b>94-059</b>	KTM: <b>94-060</b>	KTM: <b>94-061</b>	KTM: <b>94-062</b>	KTM: <b>94-063</b>
10 pcs	10 pcs	10 pcs	10 pcs	10 pcs	10 pcs	10 pcs
5 905694 023166	5 905694 023173	5 905694 023180	5 905694 023197	5 905694 023203	5 905694 023210	5 905694 023227

CAR ACCESSORIES - SAFETY

**BOOSTER CABLES 200**  
2 M



Jumper cables intended for passenger cars. For starting engines up to 1,500 cm<sup>3</sup>. Length: 2 m.

KTM: **94-035**  
20 pcs  
5 905694 015932

**BOOSTER CABLES 400**  
2,5 M



Jumper cables intended for passenger cars. To commissioning engines up to 2,500 cm<sup>3</sup>. Length: 2.5 m.

KTM: **94-036**  
12 pcs  
5 905694 015949

**BOOSTER CABLES 600**  
4 M



Jumper cables intended for passenger cars and delivery trucks. For starting engines up to 3,000 cm<sup>3</sup>. Length 4 m

KTM: **94-037**  
10 pcs  
5 905694 015956

**BOOSTER CABLES**  
400A 3 M 16 MM<sup>2</sup>



Copper jumper cables 400A. Length: 3 m.

KTM: **94-100**  
12 pcs  
5 905694 018117

**BOOSTER CABLES**  
900A 4,5 M 25 MM<sup>2</sup>



Copper jumper cables 900A. Length: 4,5 m.

KTM: **94-102**  
6 pcs  
5 905694 018131

**BOOSTER CABLES**  
1200A 6 M 35 MM<sup>2</sup>



Copper jumper cables 1200A. Length: 6 m.

KTM: **94-103**  
4 pcs  
5 905694 018148

SPARE FUEL CANISTER



A safe way to store and transport fuel. Convenient funnel for pouring. Resistant to falls from a height of 1.5 m. The product can be used at temperatures from -25°C to +50°C. Capacity: 5, 10 and 20 litres.

5 L  
KTM: **94-013**  
12 pcs



10 L  
KTM: **94-014**  
5 pcs



20 L  
KTM: **94-104**  
5 pcs



JERRY CAN BLACK



NEW



NEW



NEW

A safe way to store and transport fuel. Convenient funnel for pouring. Resistant to falls from a height of 1.5 m. The product can be used at temperatures from -25°C to +50°C. Capacity: 5, 10 and 20 litres.

5 L  
KTM: **94-064**  
12 pcs



10 L  
KTM: **94-065**  
5 pcs



20 L  
KTM: **94-066**  
5 pcs



METAL FUEL CAN



NEW



NEW



NEW

A safe way to store and transport fuel. Container made of powder-coated sheet metal, ensuring exceptional durability. Thanks to its solid construction, it guarantees long-term use, ideal for storing and transporting liquids such as gasoline or diesel oil. Additionally equipped with a safety pin to prevent access by children. For storing spare fuel for various types of equipment, such as lawn mowers, petrol saws or snow blowers. Green color. UN certificate.

5 L  
KTM: **94-067**  
8 pcs



10 L  
KTM: **94-068**  
5 pcs



20 L  
KTM: **94-069**  
4 pcs



CAR ACCESSORIES - SAFETY

SEALER 450 ML



Car tyre sealer. A spare product to be used with a compressor.

KTM: **94-029**  
30 pcs



REPAIR KIT  
(SEALER 450 ML + COMPRESSOR)



The kit includes a compressor with a 450 ml car tyre sealer. The sealer is fed automatically when the wheel is being inflated.

KTM: **94-030**  
1 pcs



CAR ACCESSORIES - TOOLS

FUNNEL FOR A METAL CANISTER



NEW

Funnel for metal canister of 5, 10, and 20 liters. Green color, powder-coated. Resistant to petroleum products. The clamp ensures quick assembly.

KTM: **94-070**  
10 pcs



2 IN 1 FUEL FUNNEL



Two-piece funnel made of durable plastic and suitable for both petrol and diesel fuel. A flexible, 25 cm long pipe allows for comfortable access to inlets. It also has a removable strainer which protects against dust or sediments getting into the tank during pouring.

KTM: **96-022**  
50 pcs



DOUBLE-SIDED TAPE  
12 MM X 2 M



Strong and durable double-sided tape. Suitable for inside and outside use. Size: 12 mm x 2 m.

KTM: **96-023**  
14 pcs



FASTENING STRAPS BLACK 100 PCS



140 x 3,6 mm

KTM: **96-007**  
250 pcs



200 x 4,8 mm

KTM: **96-008**  
60 pcs



370 x 4,8 mm

KTM: **96-009**  
50 pcs



Intended for tying, connecting cable harnesses, assembly elements. Very wide range of application. Tear resistant. They retain their properties in a wide range of temperatures (from -40°C to +85°C). Single-use product.

PLIERS 180 MM



Universal tool for everyone.

KTM: **96-013**  
6 pcs



**WORK GLOVES  
DRAGON TYPE**



Made of knitted fabric coated with very durable rubber of porous structure. Hard-wearing and wear-resistant. Tear and crack resistant.

KTM: **96-001**  
12 pcs  
5 905694 010838

**WORKING GLOVES RSE KD 614**



Made of polyester, latex-coated. Finished with a welt. The are coated with a rough structure adding perfect grip. Extensible and durable. Tear and abrasion resistant. They do not shrink after contact with water.

KTM: **96-002**  
12 pcs  
5 905694 010845

**WORKING GLOVES RSC KD 609**



Made of nitrile (grip), finished with a knitted welt. Resistant to abrasions and punctures. They ensure flexibility. Nitrile increases resistance to greases, oils, fats and hydrocarbons. Perfect for car mechanics.

KTM: **96-004**  
12 pcs  
5 905694 010869

**WORK GLOVES**



Yellow protective gloves reinforced with cowskin. Multi-coloured striped denim. Full-hand - the grip part is made of one piece of leather so they are more durable and resistant to abrasion. Commonly used for mechanical work.

KTM: **96-005**  
12 pcs  
5 905694 010876

**SPOTTED WORK GLOVES**



With single-side spots - on the palm part. 25% polyester, 75% cotton. Grammage: 420g. A combination of polyester and cotton forms a stretchy, breathable and more durable glove. Finished with a welt. Perfect for the transport industry.

KTM: **96-006**  
12 pcs  
5 905694 010883

**PROTECTIVE GLOVES DuoAir**



Made of polyester, coated with foamed latex up to the meta-carpal bones, additionally dipped in a double layer of foamed textured latex on the fingertips.

KTM: **96-025**  
10 pcs  
5 905694 023425

**NEW**

**PROTECTIVE GLOVES POLIBLACK**



Made of polyester, coated with polyurethane. The polyurethane coating provides excellent abrasion protection. They are flexible, ensuring a very good fit to the hand and providing excellent dexterity.

KTM: **96-026**  
10 pcs  
5 905694 023432

**PROTECTIVE GLOVES ClassicWint**



Insulated gloves made of polyester yarn coated with roughened latex. The insulation makes them ideal for working in low temperatures.

KTM: **96-027**  
10 pcs  
5 905694 023449

**NEW**

**PROTECTIVE GLOVES BlueFoam**



Made of polyester, coated with foamed latex up to the meta-carpal bones, additionally dipped in a double layer of foamed textured latex on the fingertips.

KTM: **96-028**  
10 pcs  
5 905694 023463

**NEW**



CAR ACCESSORIES - TOOLS

SPARK PLUG WRENCH



Intended for manual loosening and installation of spark plugs. Made of high-quality steel. The handle is covered with non-slip material.

Spark plug wrench 21 mm

KTM: **96-010**

50 pcs



5 905694 010920

Spark plug wrench 16 mm

KTM: **96-015**

50 pcs



5 905694 010975

TELESCOPIC WHEEL WRENCH 17/19



Intended for manual screwing in and loosening of car wheels mounted with a M17 or M19 bolt or nut. Made of high-quality CHROME VANADIUM steel.

KTM: **96-011**

20 pcs



5 905694 010937

KEY CROSS FOR CAR WHEELS



Used for screwing in and loosening car wheels.

KTM:

**96-012**

20 pcs



5 905694 010944

CAR SPONGE "BUTTERFLY"



Intended to remove water from windshields and car bodies. The shape of the sponge allows for firm gripping. Extremely soft, it does not scratch the car body. 50 washing cycles.

KTM: **97-003**  
30 pcs 5 905694 011132

DOUBLE SIDED CAR SPONGE "BROWN"



Intended to remove water from windshields and car bodies, the side with lighter colour is intended to wash off insects.

KTM: **97-004**  
36 pcs 5 905694 011149

SPONGE EDGED PERFORATED FOR WINDOWS



Intended to clean windshields and car mirrors. For wiping the interior car glass. Particularly useful during evening chill.

KTM: **97-005**  
30 pcs 5 905694 011156

MAGIC SPONGE



Latest generation melamine sponge for cleaning hard surfaces. Cleans effectively without detergents, even removes old dirt. Perfect for: plastic external moulding, windshields, upholstery, rims and home use.

KTM: **97-026**  
20 pcs 5 905694 018704

MICROFIBER SPONGE



Designed to clean and maintain various car surfaces as well as surfaces at home and in the office. Absorbent and soft - ideal for washing car body, windows, mirrors. To be used wet or dry. Size: 15 x 10 x 4.5 cm.

KTM: **97-006**  
50 pcs 5 905694 020974

MICROFIBER CLOTHS CAR KIT 3 PCS



Perfect for removing dust from all interior surfaces - pink colour. Perfect for cleaning glasses with no streaks - blue colour. Recommended for polishing car coatings - green colour.

KTM: **97-008**  
36 pcs 5 905694 011187

SET OF 4 PIECES MICROFIBER CLOTHS 30 X 35 CM



A set of 4 microfiber wipes sized 30 cm x 35 cm. Material composition: 85% polyester, 15% polyamide.

KTM: **97-028**  
10 pcs 5 905694 015819

SET OF 3 PIECES MICROFIBER CLOTHS 50X50 CM



A set of three microfiber cloths measuring 50 x 50 cm. Fabric composition: polyester 80%, polyamide 20%.

KTM: **97-033**  
50 pcs 5 905694 021216

CAR ACCESSORIES - SEASON

**MICROFIBER  
DRYING TOWEL**



The microfiber towel perfectly dries the car body. Super soft and absorbent - absorbs water perfectly. It does not scratch the car body. Dimension 60 x 60 cm.

KTM: **97-029**  
45 pcs 5 905694 016540

**GLASS AND MIRROR  
MICROFIBER**



Removes dirt without leaving any streaks or fiber on the glass. Perfect for car windshields, mirrors, headlights, etc. It does not lose its cleaning properties after washing. Size: 40 cm x 40 cm.

KTM: **97-031**  
45 pcs 5 905694 017608

**SYNTHETIC CHAMOIS  
64 CM X 43 CM**



The microfiber towel perfectly dries the car body. Super soft and absorbent - absorbs water perfectly. It does not scratch the car body. Dimensions: 64 x 43 cm.

KTM: **97-032**  
50 pcs 5 905694 020479

**WATER SQUEEGEE TOP DRY**



Intended to remove water from windshields and car bodies. Also used to remove water from shower stalls.

KTM: **97-002**  
30 pcs 5 905694 011125

**RUBBER BLADE ICE SCRAPER**



Designed for removing snow and ice from the car.

KTM: **97-013**  
20 pcs 5 905694 011231

**MURSKA SCRAPER  
WITH A BRASS BLADE, SHORT**



Designed for removing snow and ice from the car.

KTM: **97-021**  
150 pcs 6 417261 057522

**ICE SCRAPER  
WITH BRASS BLADE**



Designed for removing snow and ice from the car.

KTM: **97-034**  
35 pcs 5 905694 022626

**FROST SCRAPER  
WITH A BRASS BLADE**



Designed for removing snow and ice from the car.

KTM: **97-035**  
25 pcs 5 905197 190341

NEW

**UNIVERSAL WINDSHIELD COVER**  
SIZE: 200 CM X 70 CM



Universal cover - for every season of the year. In winter, it protects car windshields against frost, ice and snow. In summer, it protects against excessive heating of the car interior. The cover can also be used as a thermal blanket. It has mounting ears protecting against theft.  
Dimensions: 200 cm x 70 cm (size with eyes).

KTM: **97-007**  
50 pcs 5 905694 011170

**ALL WEATHER WINDSHIELD COVER**  
SIZE: 200 CM X 100 CM



Universal cover - for every season. In winter, it protects the car windows against frost, ice and snow. In summer, it protects against excessive heating of the car interior. The cover can also be used as a thermal blanket. It has mounting ears to protect against theft.  
Dimensions: 200 cm x 100 cm

KTM: **97-027**  
50 pcs 5 905694 021599

**BRUSH/SCRAPER 30 CM**



Designed for removing snow and ice from the car.

KTM: **97-014**  
20 pcs 5 905694 011248

**BRUSH/SCRAPER 65 CM**



Designed for removing snow and ice from the car. Comfortable handle.

KTM: **97-015**  
10 pcs 5 905694 011255

**WASHING BRUSH WITH HOSE QUICK COUPLER**



Double-honed bristles. Unique bristle design with two lengths. Gently cleans the car body with no scratching. The sprayer in the grip tip can be used to water the garden.

KTM: **97-001**  
18 pcs 5 905694 011118

**RIM BRUSH**



Hand washing brush for rims and hubcaps. Made of hard bristles, it cleans rims and hubcaps effectively, also the ones with complicated shape.

KTM: **97-025**  
6 pcs 5 905694 018698

Are you looking for products for your car and workshop?  
Visit **moje-auto.pl** and **ma-pro.com.pl**  
to find a wide selection of items.

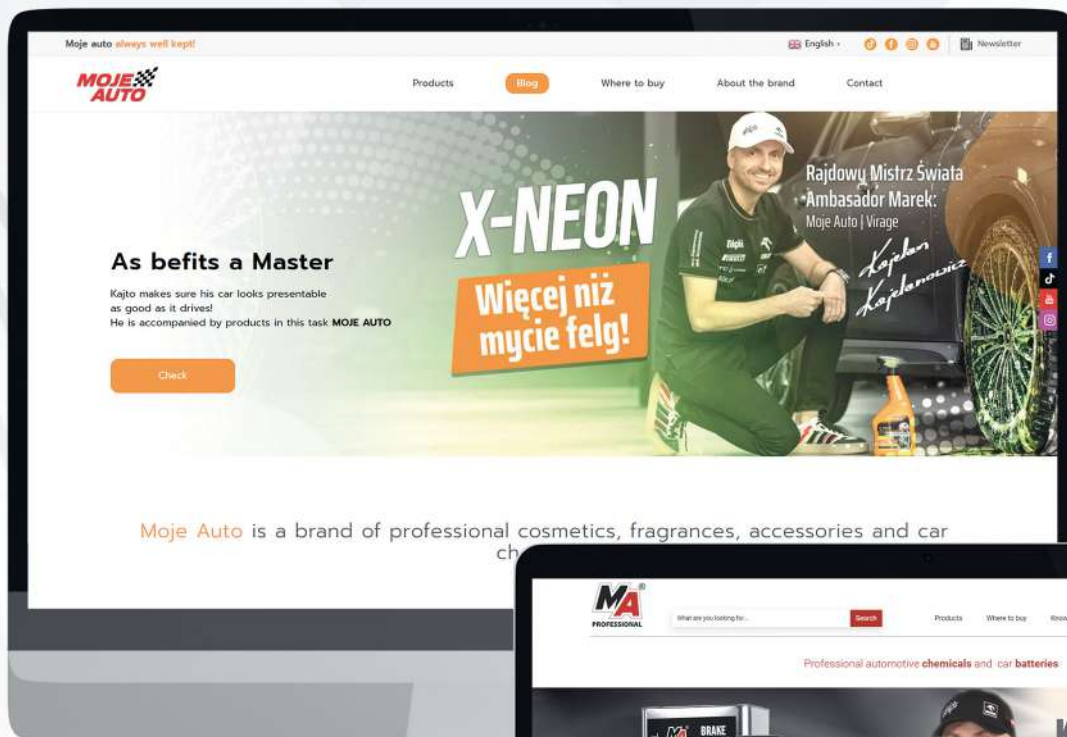

Moje Auto is a brand of professional cosmetics, fragrances, accessories and car ch

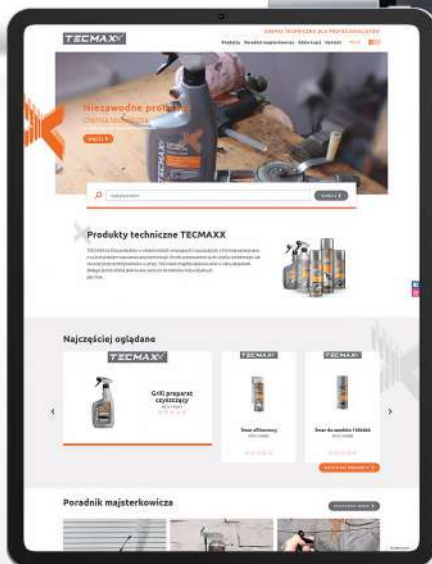
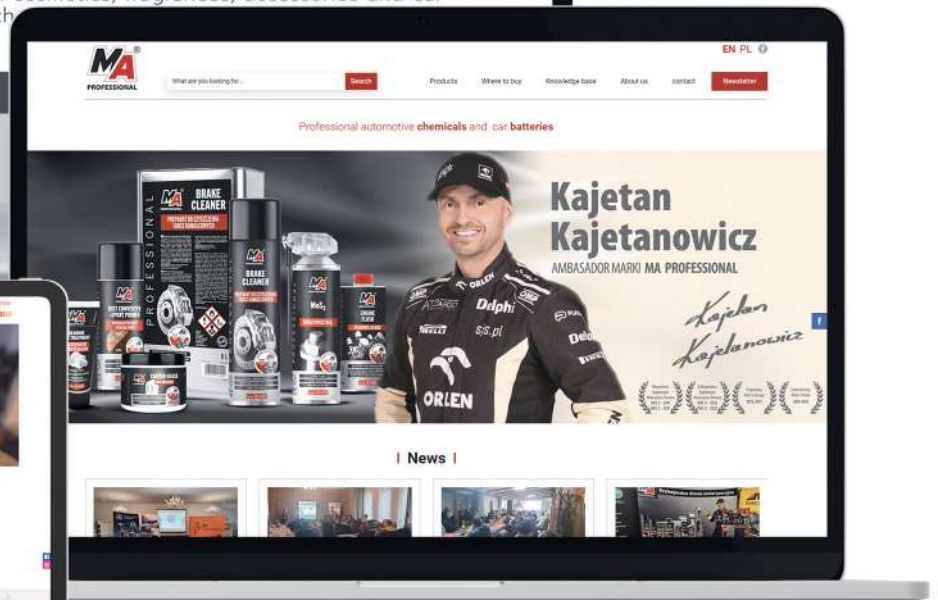

For DIY enthusiasts, we recommend **tecmaxx.pl**, which offers a range of products for even the most ambitious projects. Get inspired with us today!

Follow our **@moje\_auto\_global** account on Instagram to keep up with updates.

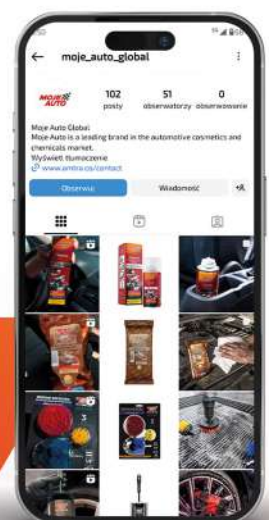



TÜVRheinland®  
**CERT**  
ISO/TS 16949

**MIKALOR**

# clamps

## and hose clamps

**MIKALOR** currently offers one of the most extensive ranges of clamps and hose clamps on the market. This manufacturer provides unique solutions, including high-pressure clamps, worm drive clamps, semi-open clamps, and titanium clamps used in Formula 1 engine bolides, as well as specialized clamps used in the automotive industry for original equipment manufacturing.

ASFA-L



Worm-drive clamps with a 9 mm band are the most popular clamps on the market, used for various mounting applications. They offer a large installation range and a high clamping force of 4 Nm. Precise embossing, raised edges, and a smooth band underside ensure easy and safe installation. The clamps are available in material specifications W1 (galvanized steel) and W2 (stainless steel). Clamps made from materials W3, W4, and W5 are available upon individual request. They are recommended for use under high pressure conditions.

ASFA-S



Worm-drive clamps with a 12 mm band, while retaining all the benefits of ASFA-L clamps, offer a higher installation torque of 6.8 Nm, ensuring complete sealing of high-pressure installations. The special clamp lock design allows for smooth closing and opening without the need for cutting. These clamps are available in material specification W1 (galvanized steel). Clamps made from materials W2, W3, W4, and W5 are available upon individual request. They are recommended for use under high pressure conditions.

MINI CLIP



Clamps made from mild steel, making them ideal for fitting to hoses during installation. They are particularly used for mounting soft and delicate hoses operating under low pressure, such as fuel hoses. Their special design ensures complete safety for the hoses they are mounted on. Made from W1 material (galvanized steel), these clamps are recommended for use under low and medium pressure conditions.

DIN 3021



Self-clamping band for heavy-duty applications, manufactured according to DIN 3021 standard. It is particularly recommended for applications where the temperature can vary from -40°C to +120°C. The design of this clamp ensures a constant clamping force despite sudden temperature changes. Quick and easy installation is an additional advantage of this clamp. Recommended for use under high pressure conditions.

WIRE CLIP



Self-clamping wire hose clamps are a cost-effective fastening solution for certain applications. They are used for securing small diameter hoses operating under low pressure, particularly those with an embedded spiral. Recommended for use under low and medium pressure conditions.

SPRING CLIP



Self-clamping spring hose clamps are designed to evenly distribute the clamping force around the mounting area. Their use is recommended when the hose is exposed to sudden temperature changes, causing expansion and contraction of the materials used in the assembly. Recommended for use under low and medium pressure conditions.

SUPER / SUPRA



High-pressure clamp designed for very demanding applications in installations operating under very high pressure. Made from the highest quality material, depending on the size, with a band width ranging from 16 to 26 mm. It ensures complete sealing in extreme conditions. The unique design and material of the clamp guarantee the highest product quality. Recommended for use under high pressure conditions.

OPASKA OTWARTA



Clamp made of soft metal with a 5 mm band, available in two sizes: 6-11 mm and 7-19 mm, designed for use in applications with limited access to the mounting area. The size and material of the clamp ensure easy and quick installation in cases of restricted access. Made from W2 material (stainless steel), they offer high corrosion resistance. Recommended for use under low and medium pressure conditions.



GALVANIZED HOSE CLAMP SET

The set includes:  
- 11 pcs of galvanized hose clamps

KTM: **52-Z01**  
12 pcs  
5 905694 011958



ASFA-L HOSE CLAMP SET

The set includes:  
- clamp hanger  
- 440 pcs of the most popular clamps  
- flexible screwdriver - FREE

KTM: **52-Z02**  
1 pc  
5 905694 013099



# professional tool in car service

**MA PROFESSIONAL** is a line of products intended for professional use in repair garages and service facilities specializing in all car systems, performing comprehensive car service and repair. The line debuted in the spring of 2013, and currently includes more than 100 specialist preparations - including lubricants in aerosol, cleaners, degreasers, maintenance products, vehicle fluids, sealants and thread lockers..



[ma-pro.com.pl](http://ma-pro.com.pl)



## POWER ENGINE CLEANER



A very strong and effective agent for cleaning engines and components. It quickly dissolves and removes even the most burnt deposits, including carbon deposits, oils, greases and other stubborn dirt.

KTM: **20-B16**  
Capacity: 1 L  
12 pcs 5 905694 020349

## ENGINE CLEANER



Removes oils and greases. It does not damage gaskets. Very effective.

KTM: **20-A32**  
Capacity: 1 L  
12 pcs 5 905694 007173

KTM: **20-A39**  
Capacity: 20 kg  
1 pcs 5 905694 011859

KTM: **20-A33**  
Capacity: 5 kg  
1 pcs 5 905694 004837

## ALU ENGINE CLEANER



Effectively removes heavy dirt from mechanical components of the engine compartment. Safe for aluminum, rubber and painted elements.

KTM: **20-A57**  
Capacity: 1 L  
12 pcs 5 905694 013129

## UNIVERSAL CLEANER



Highly effective, biodegradable detergent -based cleaner for various plastics, ceramics, painted surfaces and fabrics. Leaves the surface clean and fragrant.

KTM: **20-A55**  
Capacity: 1 L  
12 pcs 5 905694 013051

## DEGREASER



Safe for aluminum, ceramics, steel, glass, rubber. Recommended for washing parts of machines.

KTM: **20-A01**  
Capacity: 1 L  
12 pcs 5 905694 009733

## CARBURETOR CLEANER



Cleans carburetors and throttle valves. Removes carbon deposits and other dirt. Helps start the engine easier.

KTM: **20-A05**  
Capacity: 400 ml  
☐ 24 pcs



## EGR CLEANER



Cleans EGR valves and turbochargers. Removes carbon deposits and other dirt. Leaves no residues. Restores engine power. Reduces fuel consumption.

KTM: **20-A22**  
Capacity: 400 ml  
☐ 24 pcs



## EGR CLEANER



Extremely effective product removing very stubborn dirt deposited in EGR valves. It dissolves greasy and burnt soot hindering the proper functioning of the valve.

KTM: **20-A56**  
Capacity: 650 ml  
☐ 12 pcs



## THROTTLE BODY CLEANER

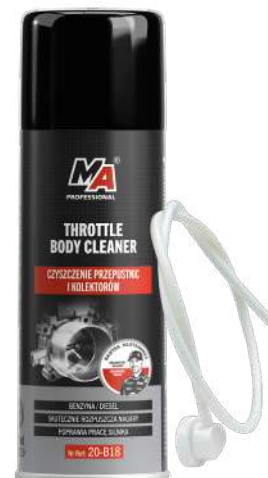

A very effective product for cleaning throttles and manifolds. It dissolves and removes burnt carbon deposits and others heavy dirt. Available with a special hose allowing for reaching throttles deep inside the system.

KTM: **20-B18**  
Capacity: 400 ml  
☐ 24 pcs



## BRAKE CLEANER



Effectively cleans and degreases. Quickly evaporates from the cleaned surface.

KTM: **20-A06**  
Capacity: 5 L  
☐ 1 pcs



KTM: **20-A26**  
Capacity: 600 ml  
☐ 12 pcs



KTM: **20-B64**  
Capacity: 750 ml  
☐ 15 pcs



KTM: **20-A107**  
Capacity: 30 L  
☐ 1 pcs



KTM: **20-B50**  
Capacity: 500 ml  
☐ 30 pcs



Intensive degreaser with the addition of acetone for quick and thorough removal of many difficult contaminants from oil, glue, paints, etc. Recommended for many assembly activities and surface preparation before gluing and painting.

KTM: **20-B70**  
Capacity: 600 ml  
☐ 12 pcs



## ACE POWER CLEANER



# CLEANING AND DEGREASING



## CONTACT CLEANER



Cleans and protects contacts and electrical connectors. It ensures proper functioning of the electrical system.

KTM: **20-A04**  
Capacity: 250 ml  
24 pcs 5 905694 009764

KTM: **20-A46**  
Capacity: 250 ml  
24 pcs 5 905694 012207

## DIESEL PARTICULATE FILTER CLEANER



Cleaning agent for DPF particulate filters located in the exhaust system. Dissolves and removes carbon deposits without the need to disassemble.

KTM: **20-A92**  
Capacity: 5 L  
1 pcs 5 905694 016106

KTM: **20-A90**  
Capacity: 400 ml  
12 pcs 5 905694 015437

## AIR FLOW SENSOR CLEANER



Quick-drying. It does not contain glycol or chlorine. Precise applicator.

KTM: **20-A50**  
Capacity: 250 ml  
24 pcs 5 905694 012320

# CONSERVATION

## UNDERSEAL



Protects the underbody and sills from stones. Prevents corrosion. Makes the underbody operate more quiet. Black colour.

KTM: **20-A09**  
Cap.: 600 ml  
24 pcs 5 905694 009818

## UNDERSEAL



Anti-corrosion coating based on bitumen and rubber protecting the underbody against stones, water and corrosion. It can also be used as a sound absorbing material, for instance on wheel arches, etc.

KTM: **20-B21**  
Cap.: 1 L  
6 pcs 5 905694 021063

## UNDERSEAL



Anti-corrosion coating based on bitumen and rubber protecting the underbody against stones, water and corrosion. It can also be used as a sound absorbing material, for instance on wheel arches, etc.

KTM: **20-B22**  
Cap.: 1 kg  
6 pcs 5 905694 021070

**ANTI GRAVEL COATING**



Spray-on anti-corrosive coating based on resins to protect sensitive painted vehicle parts such as sills, doors, wheel arches, front and rear aprons from stones, water and corrosion. Completely paintable.

KTM: **20-B19**  
Cap.: 600 ml  
24 pcs 5 905694 021049

**ANTI GRAVEL COATING**



Spray-on anti-corrosive coating based on resins to protect sensitive painted vehicle parts such as sills, doors, wheel arches, front and rear aprons from stones, water and corrosion. Completely paintable.

KTM: **20-B20**  
Cap.: 1 l  
6 pcs 5 905694 021056

**INSIDE COATING**



Protects against moisture. Prevents corrosion. Protects close profiles.

KTM: **20-A30**  
Cap.: 600 ml  
20 pcs 5 905694 011446

**RUST CONVERTER + EPOXY PRIMER  
2 IN 1**



High-quality epoxy resin-based rust neutralizer for direct application to rust. It activates on contact with rust, neutralizes it and forms a durable primer and undercoat, which can be painted after approximately eight hours. Various types of primers, paints or polyester putties can be applied to the product.

KTM: **20-B25**  
Capacity: 100 ml  
12 pcs 5 905694 021810

KTM: **20-B26**  
Capacity: 250 ml  
12 pcs 5 905694 021827

**RUST CONVERTER + EPOXY PRIMER**



High-quality rust neutralizer in aerosol form, applied directly to rust. It activates upon contact with rust, neutralizes it, and creates a durable priming coat that can be painted over after approximately eight hours. Various types of primers, paints, or polyester fillers can be applied on top of the product. The neutralizer has excellent anti-corrosion and priming properties.

KTM: **20-B39**  
Capacity: 400 ml  
12 pcs 5 905694 023289

**EPOXY PRIMER**



Epoxy primer protecting metal surfaces against corrosion. After curing, the primer can be varnished using various paints and varnishes. A special formulation containing epoxy resins allows the primer to be used directly on sheet metal, aluminum and galvanized steel. The preparation has very good adhesion to the surface and high anti-corrosion properties.

KTM: **20-B56**  
Capacity: 500 ml  
12 pcs 5 905694 024002

**NEW**

CERAMIC GREASE

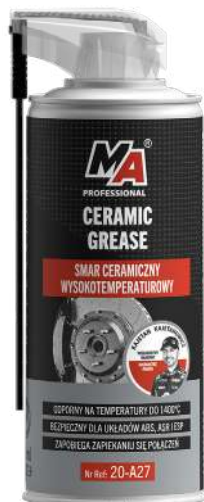

Resistant to extreme temperatures to +1400°C. Safe for ABS, ASR and ESP systems. Resistant to acids and water. It prevents mechanical connections from getting stuck. Special applicator enables precise application.

KTM: **20-A27**  
Capacity: 400 ml  
24 pcs 5 905694 011408

PTFE GREASE



Reduces friction. Operates in the range from -40°C to +180°C. Resistant to water and salt. Special applicator enables precise application.

KTM: **20-A28**  
Capacity: 400 ml  
24 pcs 5 905694 011415

KTM: **20-A70**  
Capacity: 200 ml  
24 pcs 5 905694 013433

PENETRATING SILICONE LUBE



Waterproof. Protects from moisture. Special applicator enables precise application.

KTM: **20-A48**  
Capacity: 400 ml  
24 pcs 5 905694 012238

KTM: **20-A67**  
Capacity: 200 ml  
24 pcs 5 905694 013402

SILICONE LUBE



Thick silicone grease. It does not contain solvents. Completely safe for rubber and plastic elements.

KTM: **20-A08**  
Capacity: 400 ml  
24 pcs 5 905694 009801

LUBRICANT MoS<sub>2</sub>



Removes oxides. Penetrates strongly. Protects metals.

KTM: **20-A07**  
Capacity: 400 ml  
24 pcs 5 905694 009795

KTM: **20-A71**  
Capacity: 150 ml  
24 pcs 5 905694 013501

LUBRICANT MoS<sub>2</sub>



Removes oxides. Penetrates strongly. Protects metals.

KTM: **20-A72**  
Capacity: 250 ml  
24 pcs 5 905694 013518

KTM: **20-A73**  
Capacity: 500 ml  
24 pcs 5 905694 013525

**WHITE GREASE**



It easily penetrates areas that are difficult to access, it does not drip from vertical surfaces. Displaces water and protects against corrosion. Lubricates and protects seat hinges, guides, etc.

KTM: **20-A03**  
Capacity: 400 ml  
24 pcs 5 905694 009757

KTM: **20-A68**  
Capacity: 200 ml  
24 pcs 5 905694 013419

**WHITE LITHIUM GREASE**



Multipurpose NLGI 2 grade lubricant. Owing to the white colour, it is well visible on the surface. Resistant to high pressure. Recommended for most bearings, moving joints and screws operating under normal load, used in devices and motor vehicles, in households and in industry. It lubricates, reduces wear and rejects water.

KTM: **20-A44**  
Cap.: 400 ml  
24 pcs 5 905694 017790

**HIGH LOAD BEARING GREASE EP2**



Effectively reduces the wear of bearings. Resistant to high temperatures from -30 to 180°C. Contains a special formulation of carefully selected additives which provide extraordinary anti-wear and anti-corrosive properties. Distinguished by its very high adhesion and resistance to water washing.

KTM: **20-A49**  
Cap.: 400 ml  
12 pcs 5 905694 016373

**COPPER GREASE SPRAY 1000°C**



Water resistant. Protects against corrosion, prevents seizure of parts. Resistant to temperature from -40°C to +1000°C.

KTM: **20-A10**  
Capacity: 400 ml  
24 pcs 5 905694 009825

KTM: **20-A69**  
Capacity: 200 ml  
24 pcs 5 905694 013426

**CHAIN LUBE**



Lubricant for motorcycle chains. Penetrates quickly, and then solidifies in the form of thick lubricating paste. Distinguished by its very high adhesion and resistance to water washing. Contains a special formulation of additives with extraordinary anti-wear and anti-corrosive properties. Suitable for O-rings, Z-rings, and X-rings.

KTM: **20-A93**  
Cap.: 400 ml  
24 pcs 5 905694 016489

**HI TACK GREASE**



Semi-synthetic, waterproof grease with additives that ensure excellent lubricating properties, long-term operation and anti-corrosion protection. It is characterised by a very high resistance to high pressure, impact shocks, vibrations and loads. Designed for the lubrication of highly loaded elements. It is resistant to temperatures ranging from -25°C to +220°C.

KTM: **20-B03**  
Cap.: 400 ml  
12 pcs 5 905694 019169

## INJECTOR GREASE



Special semi-synthetic grease for installation of injectors and glow plugs, and other applications exposed to very high temperatures. The product allows for easier disassembling of protected elements. The grease rejects moisture and protects against corrosion. Operating temperature: -40 to 1400°C.

KTM: **20-A102**

Cap.: 50 g

12 pcs



## BRAKE CALIPER LUBE



Special grease for lubrication of moving parts in the brake system such as clamps, guides, pins and pistons during installation. It ensures proper functioning of the system. It prevents corrosion and seizure. Operating temperature: -40 to 220°C.

KTM: **20-A103**

Cap.: 50 g

12 pcs



## CERAMIC LUBE



Strongly adhesive ceramic grease resistant to extreme loads and temperatures up to 1400°C. It protects highly loaded elements exposed to weather conditions against wear. It protects metal elements against corrosion and the so-called electrolytic corrosion. It does not contain metals. Operating temperature: -40 to 1400°C.

KTM: **20-A104**

Cap.: 50 g

12 pcs



## HIGH LOAD BEARING GREASE EP2



High-performance bearing grease. Guarantees excellent lubricating properties. Reduces rolling friction. Effectively reduces bearing wear. Distinguished by its very high adhesion to surfaces and resistance to water washing. Operating temperature: -30 to 180°C.

KTM: **20-A105**

Cap.: 50 g

12 pcs



## COPPER GREASE



Copper-based grease protecting metal components operating at high temperatures. Prevents seizure and blocking of mechanisms.

KTM: **20-A58**

Capacity: 500 g

12 pcs



## CERAMIC GREASE

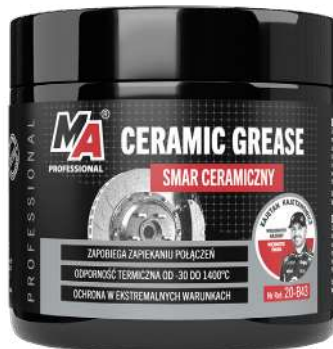

Ceramic assembly paste resistant to extreme temperatures and loads. Dedicated to automotive applications and demanding industries. The product is recommended for works on the assembly of braking systems with ABS and ESP systems, and wherever there is a temperature above 300°C at which ordinary lubricants begin to condense.

KTM: **20-B43**

Capacity: 500 g

12 pcs



## BEARING GREASE



High-quality bearing grease enriched with special EP2 additives that provide maximum protection for heavily loaded bearings operating in difficult conditions. It radically reduces friction and wear, shows high resistance to water and oxidation. Protects against corrosion. Perfect for lubricating all types of rolling and sliding bearings operating in a wide range of temperatures. The grease is highly resistant to mechanical and thermal aging factors.

KTM: **20-B44**

Capacity: 500 g

12 pcs



**SILICONE GREASE**

**NEW**



High-temperature, universal silicone grease designed to lubricate and protect metal, glass, ceramics and plastics. It forms a thin, colorless lubricating film that eliminates friction. The product has excellent preservative and caring properties. Thanks to strong hydrophobic properties, it protects the interior of locks against freezing. The agent has antistatic properties and prevents creaking. It is ideal for lubricating cooperating elements made of various materials, e.g. metal and plastic.

KTM: **20-B45**  
Capacity: 500 g  
12 pcs 5 905694 023562

**MOLYBDENUM GREASE**

**NEW**

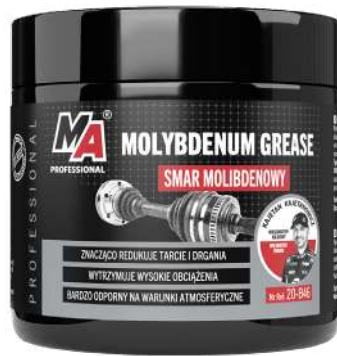

High-quality grease with anti-seize additives (molybdenum disulfide) designed for use in the most difficult operating conditions. Perfectly withstands high loads. Dedicated to joints and other very demanding applications in truck transport and heavy industry. The special composition of lithium thickener, lubricant additives and molybdenum disulfide allows for use in places particularly exposed to high dust levels and the presence of water. The grease is characterized by very good mechanical stability, oxidation and corrosion resistance.

KTM: **20-B46**  
Capacity: 500 g  
12 pcs 5 905694 023579

**GRAPHITE GREASE**

**NEW**



Grease especially recommended for lubrication and protection of elements exposed to high loads and weather conditions, such as: vehicle springs, truck saddles, open gears and other heavily loaded elements. High water resistance, good corrosion protection. Excellent adhesion to the substrate of elements operating in the temperature range from -20°C to +60°C. Not suitable for the lubrication of rolling and plain bearings.

KTM: **20-B47**  
Capacity: 500 g  
12 pcs 5 905694 023586

**COPPER GREASE**

**NEW**



High-quality copper-based grease to protect metal parts operating at high temperatures. Prevents corrosion and seized and blocked connections. Allows subsequent quick and safe disassembly. Copper grease is not recommended for aluminum components.

KTM: **20-B48**  
Cap.: 50 g  
12 pcs 5 905694 023524

**SILICONE GREASE**

**NEW**



High-temperature, universal silicone grease designed to lubricate and protect metal, glass, ceramics and plastics. It forms a thin, colorless lubricating film that eliminates friction. The product has excellent preservative and caring properties. Thanks to strong hydrophobic properties, it protects the interior of locks against freezing. The agent has antistatic properties and prevents creaking. It is ideal for lubricating cooperating elements made of various materials, e.g. metal and plastic.

KTM: **20-B49**  
Cap.: 50 g  
12 pcs 5 905694 023531

**BEARING GREASE**

**NEW**



A universal lithium grease for use in all anti-friction and plain bearings subjected to regular conditions. It can also be used to lubricate low-speed gears, joints and guides. Resistant to washing out with water, provides protection against corrosion in a humid environment. It has a wide range of applications throughout the industry and automotive sector.

KTM: **20-B60**  
Cap.: 400 g  
12 pcs 5 905694 024231

**BEARING GREASE EP2**

**NEW**



A premium quality lithium grease for use in all anti-friction and plain bearings subjected to high load conditions. It can also be used to lubricate low-speed gears, joints and guides. Resistant to washing out with water, provides protection against corrosion in a humid environment. It has a wide range of applications throughout the industry and automotive sector.

KTM: **20-B61**  
Cap.: 400 g  
12 pcs 5 905694 024248



# TABLE OF PROPERTIES OF MA PROFESSIONAL LUBRICANTS



KTM	Product	Packing	Capacity / Weight	Penetration	Lubrication	Resistance to weather conditions	Resistance to temperature	Additional functions	Typical applications
<b>20-A03</b> <b>20-A68</b>	White Grease	spray	400 ml 200 ml	medium	high	high	up to 120°C	Penetrates tight connections and solidifies into a lubricating paste.	Door hinges, seat rails door stoppers
<b>20-A08</b>	Silicone Lube	spray	400 ml	medium	high	medium	up to 160°C	Universal, solvent-free, safe for rubber.	Setting of rubber hoses on metal nipples, protection of rubber seals
<b>20-A10</b> <b>20-A69</b>	Copper Grease	spray	400 ml 200 ml	medium	high	medium	up to 1000°C	Prevents the seizing of connections at high temperatures.	Wheel hub pins, screws in the exhaust system
<b>20-A27</b>	Ceramic Grease	spray	400 ml	low	high	high	up to 1400°C	Prevents the seizing of connections at high temperatures, safe for aluminum.	Greasing elements in the braking system, such as calipers, pivots
<b>20-A28</b> <b>20-A70</b>	PTFE Grease	spray applicator	400 ml 200 ml	high	high	high	up to 120°C	Thanks to the content of PTFE, it significantly reduces friction.	Lubrication of various mechanic chains
<b>20-A44</b>	White Lithium Grease	spray	400 ml	medium	high	high	up to 150°C	Penetrates tight connections and solidifies into a lubricating paste.	Hinges, doors, locks, engine and trunk covers
<b>20-A48</b> <b>20-A67</b>	Penetrating Silicone Lube	spray applicator	400 ml 200 ml	very high	medium	medium	up to 100°C	Seals the cooperating moving parts of actuators.	Greasing of small elements
<b>20-A49</b>	High Load Bearing Grease EP2	spray	400 ml	medium	high	high	up to 180°C	Significantly reduces friction, extending the lifespan of bearings.	Lubrication of bearings
<b>20-A58</b> <b>20-B48</b>	Copper Grease High Temperature	can tube	500 g 50 g	very low	high	very high	up to 1000°C	Prevents the seizing of connections at high temperatures.	Manifold mounting screws, screws in the exhaust system, hub pins
<b>20-A93</b>	Chain Lube	spray	400 ml	high	high	high	up to 150°C	Thanks to the PTFE content, it remains visible on the surface of the chain.	Lubricant for motorcycle chains
<b>20-A102</b>	Injector Grease	tube	50 g	low	high	high	up to 1400°C	Prevents the seizing of connections at high temperatures.	Glow plugs, injectors, and other highly stressed components operating at very high temperatures.
<b>20-A103</b>	Brake Lube	tube	50 g	low	high	high	up to 220°C		Lubrication of brake pistons during assembly.
<b>20-A104</b> <b>20-B43</b>	Ceramic Lube	can tube	500 g 50 g	low	high	high	up to 1400°C	Prevents the seizing of connections at high temperatures, safe for aluminum.	Wheel hub studs, manifold bolts, exhaust system bolts, and other connections operating at high temperatures.
<b>20-A105</b>	Hi Load Bearing Grease EP2	tube	50 g	low	high	high	up to 180°C	Significantly reduces friction, extending the lifespan of bearings.	Lubrication of bearings.
<b>20-B03</b>	High Adhesion Grease	spray	400 ml		high	high		High protection factor against atmospheric agents.	Lubrication of guides, lines, and other equipment operating under heavy load.
<b>20-B44</b>	Bering Grease EP 2	can	500 g	very low	high	high	up to 180°C	Significantly reduces friction, extending the lifespan of bearings.	Lubrication of bearings.
<b>20-B45</b> <b>20-B49</b>	Silicone Grease	can tube	500 g 50 g	very low	high	high	up to 230°C	High resistance to water and temperature..	
<b>20-B46</b>	Molybdenum Grease	can	500 g	very low	high	high	up to 140°C	Withstands high loads, resistant to atmospheric conditions.	Lubrication of joints and other highly demanding applications in heavy transport and heavy industry.
<b>20-B47</b>	Graphite Grease	can	500 g	very low	high	high	up to 60°C	Withstands high loads, resistant to atmospheric conditions.	Lubrication and protection of components operating in adverse weather conditions and subjected to high loads.
<b>20-B60</b>	Bering Grease tT43	cartouche	400 g	very low	high	high	up to 130°C		Lubrication of bearings.
<b>20-B61</b>	Bering Grease EP2	cartouche	400 g	very low	high	high	up to 140°C		Lubrication of bearings.

**RED HI-TEMP SILICONE GASKET MAKER**



Replaces traditional gaskets. Safe for oxygen sensors. Resistant to high temperatures to +343°C.

KTM: **20-A35**  
Capacity: 290 g  
12 pcs 5 905694 011521

KTM: **20-A12**  
Capacity: 85 g  
12 pcs 5 905694 009863

KTM: **20-A17**  
Capacity: 32 g  
12 pcs 5 905694 010029

**BLACK HI-TEMP SILICONE GASKET MAKER NEUTRAL**



Replaces traditional gaskets. Safe for oxygen sensors. Resistant to high temperatures to +329°C.

KTM: **20-A34**  
Capacity: 290 g  
12 pcs 5 905694 011514

KTM: **20-A11**  
Capacity: 85 g  
12 pcs 5 905694 009856

KTM: **20-A16**  
Capacity: 32 g  
12 pcs 5 905694 010012

**GREY HI-TORQUE SILICONE GASKET MAKER NEUTRAL 399°C**



Replaces traditional gaskets. Safe for oxygen sensors. Resistant to high loads and temperatures to +399°C. Acetic-free.

KTM: **20-A13**  
Capacity: 100 g  
12 pcs 5 905694 009870

KTM: **20-A18**  
Capacity: 32 g  
12 pcs 5 905694 010036

**EXHAUST SYSTEM CEMENT**



Solidifies quickly. Eliminates exhaust blow-by. Mutes the exhaust system.

KTM: **20-A53**  
Capacity: 150 g  
12 pcs 5 905694 012337

**EPOXY 5 MINUTES CLEAR DOUBLE SYRINGES 25 ML**



Quick-drying transparent epoxy glue intended for repairing damaged/cracked objects made of various hard materials such as wood, ceramics, plastic, glass and many others. It creates a very hard binder resistant to atmospheric conditions and temperatures up to 80°C. After hardening, it is resistant to car, gear and hydraulic oils, gasoline, water and many other substances. Initial hardening after 4 to 10 minutes depending on the ambient temperature. After one hour, the product is 80% hardened. Full hardening occurs after 24 hours.

KTM: **20-B71**  
Capacity: 25 ml  
12 pcs 5 905694 024736

**SUPER METAL EXTREME 70% STALI 10 MIN.**



Highest quality epoxy-steel repair putty containing 70% steel, designed for quick and durable repairs of damaged components made from various metals. It quickly hardens to form a very hard joint that is resistant to atmospheric conditions, chemicals, and temperatures ranging from -60°C to 120°C. After full curing, the joint can be mechanically processed or painted. The putty has extraordinary properties for filling gaps in the material.

KTM: **20-B71**  
Capacity: 25 ml  
12 pcs 5 905694 024811

## EPOXY METAL 5 MIN



Solidifies quickly (5 minutes). Resistant to over 170 standard atmospheres. When it solidifies, it can be processed mechanically.

KTM: **20-A43**  
 Cap.: 25 ml  
 12 pcs 5 905694 011989

## GREY POWER PLASTIC EXTREME



Methacrylate structural adhesive for very strong bonding / filling of numerous materials. Resistant to weather conditions and temperatures from -40°C to +180°C.

KTM: **20-A99**  
 Cap.: 25 ml  
 12 pcs 5 905694 017837

## BLACK POWER PLASTIC EXTREME



Methacrylate structural adhesive for very strong bonding / filling of numerous materials. Resistant to weather conditions and temperatures from -40°C to +180°C.

KTM: **20-A100**  
 Cap.: 25 ml  
 12 pcs 5 905694 017844

## INSTANT STRUCTURAL ADHESIVE



Bonds immediately (2 - 6 seconds). It has an applicator enabling precise dosage

KTM: **20-A45**  
 Cap.: 10 g  
 12 pcs 5 905694 012061

## PLASTIC WELD GREY



Withstands over 270 standard atmospheres. Solidifies in 10 minutes. Works on joined surfaces.

KTM: **20-A42**  
 Cap.: 25 ml  
 12 pcs 5 905694 011972

## PLASTIC WELD BLACK



Withstands over 270 standard atmospheres. Solidifies in 10 minutes. Works on joined surfaces.

KTM: **20-A54**  
 Cap.: 25 ml  
 12 pcs 5 905694 012795

## SPRAY ADHESIVE



It glues various materials permanently and quickly. Waterproof and flexible.

KTM: **20-A37**

Cap.: 400 ml

5 905694 011583

24 pcs

## BLACK AUTOMATIC SILICONE GASKET MAKER 260°C



Black silicone sealant used to form permanent seals of mechanical components. Automatic pressure container facilitates spreading of the sealing mass. Resistant to temperature to 260°C.

KTM: **20-A97**

Cap.: 200 ml

5 905694 017639

12 pcs

## GREY AUTOMATIC SILICONE GASKET MAKER 260°C



Black silicone sealant used to form permanent seals of mechanical components. Automatic pressure container facilitates spreading of the sealing mass. Resistant to temperature to 260°C.

KTM: **20-B23**

Cap.: 200 ml

5 905694 021155

12 pcs

## FUEL TANK REPAIR KIT



Repair mass for quick and permanent repair of damaged/ perforated metal fuel tanks. When solidified, it is highly resistant to gasoline and diesel fuel.

KTM: **20-B15**

Cap.: 56 g

5 905694 020257

12 pcs

## EPOXY ALUMINIUM REPAIR



Repair mass for quick and permanent repair of damaged/ cracked elements made of aluminium and other metals.

KTM: **20-B17**

Cap.: 56 g

5 905694 020585

12 pcs

## COLD WELDING COMPOUND 4 MINUTES



Strong as steel. Solidifies quickly - 4 minutes. Suitable for mechanical machining.

KTM: **20-A40**

Cap.: 56 g

5 905694 011873

12 pcs

**THREADLOCK  
MEDIUM STRENGTH  
BLUE MA243**



Prevents loosening of connections. Seals joints. Prevents corrosion.

KTM: **20-A14**  
Cap.: 10 ml  
12 pcs 5 905694 010043

**THREADLOCK  
HIGH STRENGTH  
RED MA262**



Prevents loosening of connections. Seals joints. Prevents corrosion. Withstands high loads.

KTM: **20-A15**  
Cap.: 10 ml  
12 pcs 5 905694 010050

**THREADLOCK  
MEDIUM STRENGTH  
BLUE MA243**



Prevents loosening of connections. Seals joints. Prevents corrosion.

KTM: **20-A88**  
Cap.: 6 ml  
12 pcs 5 905694 015109

**THREADLOCK  
HIGH STRENGTH  
RED MA262**



Prevents loosening of connections. Seals joints. Prevents corrosion. Withstands high loads.

KTM: **20-A89**  
Cap.: 6 ml  
12 pcs 5 905694 015116

**THREADLOCKER BLUE**



Prevents loosening of connections. Seals joints. Prevents corrosion.

KTM: **20-B01**  
Cap.: 10 ml  
12 pcs 5 905694 018711

**THREADLOCKER RED**



Prevents loosening of connections. Seals joints. Prevents corrosion. Withstands high loads.

KTM: **20-B02**  
Cap.: 10 ml  
12 pcs 5 905694 018728

**THREADLOCKER BLUE**



Prevents loosening of connections. Seals joints. Prevents corrosion.

KTM: **20-A96**  
Cap.: 50 ml  
12 pcs 5 905694 017516

**THREADLOCKER RED**



Prevents loosening of connections. Seals joints. Prevents corrosion. Withstands high loads.

KTM: **20-A95**  
Cap.: 50 ml  
12 pcs 5 905694 017509

## SUPER ACTIVE FOAM



Concentrated foaming agent for washing passenger car bodies. Combination of high performance with additives adding gloss to the paint, it produces excellent visual effects.

KTM: **20-A80**  
Capacity: 1 kg  
5 905694 013983

KTM: **20-A81**  
Capacity: 5 kg  
5 905694 013990

## DIMMEX 2-FAZE



Very concentrated foaming solution for preliminary and proper washing. Effectively dissolves and removes road dirt, fat, grease and other stubborn stains without the use of a brush or sponge.

KTM: **20-A84**  
Capacity: 10 kg  
5 905694 015963

KTM: **20-A82**  
Capacity: 5 kg  
5 905694 014072

## DEFATEX



Has a strong degreasing effect. Safe for all surfaces.

KTM: **20-A02**  
Capacity: 5 L  
5 905694 009740

## ANTY-OIL



Dissolves grease and lubricants effectively. For daily care. For manual and machine washing.

KTM: **20-A19**  
Capacity: 5 L  
5 905694 009993

## ACTIVE MIX



Very concentrated foaming solution for preliminary and proper washing. Effectively dissolves and removes road dirt, fat, grease and other stubborn stains without the use of a brush or sponge.

KTM: **20-B66**  
Capacity: 1 L  
5 905694 024651

KTM: **20-B62**  
Capacity: 5 L  
5 905694 024286

NEW

ENGINE FLUSH



Safe for all types of engines. Cleans quickly and effectively.

KTM: **20-A38**  
Cap.: 374 ml  
24 pcs  
5 905694 021759

ENGINE FLUSH POWER TEC



NEW

Professional preparation for flushing the oil system of combustion engines, based on high-performance solvents and toluene. It effectively dissolves hard carbon deposits, sludge, and other contaminants. It releases seized rings, increases compression in cylinders, and enhances engine power. It restores full flow capacity to oil channels.

KTM: **20-B40**  
Cap.: 500 ml  
12 pcs  
5 905694 023296

KTM: **20-B65**  
Cap.: 2,5 l  
6 pcs  
5 905694 024644

DIESEL ENGINE FLUSH POWER TEC



NEW

Professional preparation for intensive flushing of the oil system of diesel engines based on high-performance solvents. Quickly and effectively dissolves hard carbon deposits and other difficult-to-remove dirt occurring in the lubrication system of diesel engines. Prepares the oil system for new oil.

KTM: **20-B67**  
Cap.: 500 ml  
12 pcs  
5 905694 024682

MOTO START



Effective even to -50°C. Safe for all types of engines. For petrol engines, diesel engines, motorcycles, lawn mowers, saws.

KTM: **20-A20**  
Cap.: 200 ml  
24 pcs  
5 905694 010128

CERAMIC ENGINE PROTECTOR



New generation multi-functional ceramic engine oil additive to protect the engine even under the most extreme conditions. Significantly reduces friction, quieter the engine and lowers fuel consumption.

KTM: **20-B28**  
Cap.: 300 ml  
12 pcs  
5 905694 022527

ATF FLUSH



Highly efficient preparation for flushing automatic gearboxes before changing the oil. Dissolves and removes deposits and other contaminants found in automatic transmissions, ensures optimum transmission efficiency and improves smooth shifting performance.

KTM: **20-B29**  
Cap.: 300 ml  
12 pcs  
5 905694 022534

ENGINE OIL STOP LEAK



NEW

Stops and prevents oil leaks through seals and eliminates the need for costly repairs. Reduces oil consumption. Restores flexibility to old seals and gaskets, thereby reducing leaks and oil burning through valve seals.

KTM: **20-B51**  
Cap.: 300 ml  
12 pcs  
5 905694 023951

## GEARBOX OIL TREATMENT

**NEW**



A professional additive for transmission oil that reduces friction and wear of drive transmission components. It significantly improves the durability of the lubricating film and reduces noise from worn mechanisms, ensuring long and efficient operation of the gearbox. It eliminates minor leaks. The product can be used in manual transmissions and differentials.

KTM: **20-B41**  
 Cap.: 150 ml  
 12 pcs  
 5 905694 023319

## ENGINE DOKTOR

**NEW**



A modern, high-performance engine oil additive that stabilizes its viscosity and durability at high temperatures. It reduces oil consumption in gasoline and diesel engines. Enhances compression and quiets engine operation. Provides additional protection for highly worn engines. This engine oil additive is suitable for engines showing signs of wear.

KTM: **20-B42**  
 Cap.: 444 ml  
 24 pcs  
 5 905694 023388

## DIESEL FLUSH



Professional concentrated preparation for cleaning the entire injection system and combustion chamber in diesel engines. It saves fuel, significantly improves the combustion process. Restores engine power and performance. It can be used in all types of diesel engines.

KTM: **20-B30**  
 Cap.: 500 ml  
 12 pcs  
 5 905694 022541

## DISPOSABLE NITRILE GLOVES BLACK 500

**NEW**



Black nitrile gloves, disposable, resistant to tearing and abrasion.

Size L  
 KTM: **20-RN1**  
 Quantity per package 100 pcs  
 10 pcs  
 8 426241 449880

Size XL  
 KTM: **20-RN2**  
 Quantity per package 100 pcs  
 10 pcs  
 8 426241 449897

## BELT DRESSING



Prevents the v-belt from slipping. Extends its lifetime. Eliminates squeaks. Increases the belt's effectiveness.

KTM: **20-A29**  
 Cap.: 400 ml  
 24 pcs  
 5 905694 011439

## COMPRESSED AIR FREEZE SPRAY -50°C



Compressed air for blowing dust out of hard-to-reach places or for freezing. In the up-valve position, a powerful jet of compressed air blows dusts away from hard-to-reach places, while when the container is turned 180° with the valve down, it acts as a freezer.

KTM: **20-B24**  
 Cap.: 600 ml  
 15 pcs  
 5 905694 021179



## OTHER SERVICE PRODUCTS



### INJECTOR LOOSENER WITH PTFE



A product facilitating disassembly of injectors, glow plugs and other seized and corroded joints, with a freezing effect. It penetrates perfectly, and rapidly cools tight and corroded connections to facilitate their disassembly.

KTM: **20-A98**  
Cap.: 400 ml  
24 pcs 5 905694 017646

### LPG TESTER



For all gas media and air conditioning. Totally non-flammable. Works in an inverted position of 180°.

KTM: **20-A25**  
Cap.: 500 ml  
24 pcs 5 905694 011385

### HAND CLENER



A very effective paste gentle to the hands, with added abrasive to remove stubborn dirt from the hands. It does not dry out the skin owing to the content of skin care ingredients. It has undergone comprehensive dermatological tests required for cosmetics.

KTM: **20-A61**  
Cap.: 5 kg  
1 pcs 5 905694 013273

KTM: **20-A60**  
Cap.: 600 g  
12 pcs 5 905694 013266

### HAND CLENER MAX



High-quality paste for cleaning very dirty hands, based on natural agents and wood-chips. Contains cosmetic agents regenerating damaged hands. It has undergone comprehensive dermatological tests required for cosmetics.

KTM: **20-B27**  
Cap.: 5 kg  
1 pcs 5 905694 022114

KTM: **20-A62**  
Cap.: 450 g  
12 pcs 5 905694 020271

## POWER STEERING FLUIDS

### POWER STEERING FLUID



High-quality mineral oil intended for power steering systems of vehicles compliant with Dexron II D specification. Ensures proper operation of the pump.

KTM: **20-A78**  
Cap.: 1 L  
12 pcs 5 905694 013914



KTM: **20-A79**  
Cap.: 500 ml  
12 pcs 5 905694 013921

### POWER STEERING FLUID WITH STOP LEAK



Power steering fluid with sealant, eliminates fluid leaks effectively. Contains high-quality oil enriched with additives that regenerate old seals. Miscible with any other power-assisted steering fluid.

KTM: **20-A91**  
Cap.: 300 ml  
12 pcs 5 905694 015444

## RADIATOR DEGREASER



Removes oil from the cooling system. Prevents corrosion of the system. Safe for the whole cooling system.

KTM: **20-A47**  
 Cap.: 1 L  
 12 pcs  
 5 905694 012146

## RADIATOR SEALANT



Effectively eliminates leaks. It does not clog channels of the cooling system. For all types of radiators and heaters.

KTM: **20-A41**  
 Cap.: 400 ml  
 12 pcs  
 5 905694 011880

## RADIATOR FLUSH



Cleans the cooling system quickly. It prevents the engine from overheating. For all types of radiators.

KTM: **20-A31**  
 Cap.: 400 ml  
 12 pcs  
 5 905694 007005

# OPERATING FLUIDS

## BRAKE FLUID DOT 3



NEW

DOT 3 is a universal brake fluid with very good performance properties, used in the braking systems of medium loaded vehicles. Intended for hydraulic braking and clutch systems of passenger cars, trucks, buses, trailers, motorcycles, etc. in accordance with the vehicle manuals where the manual requires the use of DOT-3 fluid.

KTM: **20-B52**  
 Capacity: 485 g  
 24 pcs



## BRAKE FLUID DOT 4



NEW

DOT-4 is a modern brake fluid with very good functional properties, characterized by a boiling point above 230°C. It is intended for hydraulic brake and clutch systems of passenger cars, trucks, buses, trailers, motorcycles, battery trolleys, etc. in accordance with the vehicle operating instructions.

KTM: **20-B53**  
 Capacity: 1 kg  
 17 pcs



KTM: **20-B63**  
 Capacity: 485 g  
 24 pcs



KTM: **20-B54**  
 Capacity: 5 kg  
 4 pcs



## BRAKE FLUID DOT 5.1



NEW

DOT 5.1 is the highest quality brake fluid intended mainly for brake and clutch systems of high-power vehicles operating in extreme operating conditions and for sports cars, as well as for ABS, ESP, ASR and other systems generating extremely high fluid temperatures. Ensures safety and high braking efficiency. Suitable for braking systems that are designed to use synthetic fluids.

KTM: **20-B55**  
 Capacity: 485 g  
 24 pcs



BRAKE CALIPER SPRAY



The enamel is intended for protecting brake calipers and drums against corrosion made on the basis of the highest quality resins. It creates a durable coating with a very high gloss, resistant to brake dust, salt, chemicals and gasoline. It has anti-corrosive properties. The paint withstands heating up to 160°C. The product can be used in car tuning. The paint is resistant to abrasion, scratches, bumps and petrol. Available in 4 colors (black, red, silver, yellow).

RED

KTM: **20-B33**

Cap.: 400 ml

12 pcs



YELLOW

KTM: **20-B34**

Cap.: 400 ml

12 pcs



BLACK

KTM: **20-B35**

Cap.: 400 ml

12 pcs



SILVER

KTM: **20-B36**

Cap.: 400 ml

12 pcs



ACRYLIC SPRAY PAINT BLACK



NEW



NEW

ACRYLIC SPRAY PAINT TRANSPARENT



NEW

Quick-drying acrylic varnish with very good covering properties, intended for painting various surfaces, including wooden, metal, aluminum, etc. It can also be used to renew old coatings or, for example, laminates.

Quick-drying acrylic varnish for painting and protecting various surfaces, including wooden, metal, aluminum, etc. It can also be used to renew old coatings or, for example, laminates.

MATTE

KTM: **20-B57**

Cap.: 400 ml

12 pcs



GLOSS

KTM: **20-B58**

Cap.: 400 ml

12 pcs



KTM: **20-B59**

Cap.: 400 ml

12 pcs



**OIL FILTER BAND WRENCH**



**NEW**

Oil filter wrench made of a steel clamp band, featuring ridges that prevent the wrench from slipping on the filter. The handle is covered with rubber and equipped with a joint, making it easier to work in hard-to-reach areas.

Supported filter diameters: 60-73 mm

Supported filter diameters: 73-83 mm

KTM: **20-N01**  
36 pcs 5 905694 023777

KTM: **20-N02**  
36 pcs 5 905694 023784

**OIL FILTER WRENCH**



**NEW**

Oil filter wrench made of a steel clamp band, featuring ridges that prevent the wrench from slipping on the filter. The clamp allows for wide adjustment.

Supported filter diameters: 60-105 mm

KTM: **20-N03**  
50 pcs 5 905694 023791

**GUN WITH PRESSURE GAUGE FOR INFLATING WHEELS**



**NEW**

Tire inflator gun with pressure gauge. Equipped with a standard 1/4" plug compatible with quick connectors. The gauge is protected by a special rubber cover to prevent potential damage. A thumb-accessible valve allows for air pressure adjustment in the tire. The gun is made of high-quality aluminum alloys, making it ideal for tire repair shops.

KTM: **20-N04**  
50 pcs 5 905694 023807

**PLIERS WITH CORD FOR CABLE TIES**



**NEW**

The pliers are used for clamping expansion clamps on flexible, fuel, oil, and water hoses. They also feature a five-step mechanism that automatically locks them in the closed position. The long cable (630 mm) allows for work in hard-to-reach places.

KTM: **20-N05**  
30 pcs 5 905694 023814

**MAGNETIC STRIP 50 CM**



**NEW**

The magnetic strip allows for the storage of various tools such as wrenches, screwdrivers, and pliers. It is made of a steel profile filled with a magnet. The strip can hold a weight of up to 13 kg. This tool strip facilitates workshop work by organizing and displaying the most needed tools. The strip can be mounted on walls made of brick, concrete, drywall, or wood.

KTM: **20-N06**  
10 pcs 5 905694 023821

**WIPER ARM PULLER**



**NEW**

Professional two-arm puller for terminals and wiper arms, featuring a strong construction and locking screw. It can also handle bearings and bushings within the range of 5 mm to 130 mm.

KTM: **20-N07**  
50 pcs 5 905694 023838

WIRING HARNESS TAPE



NEW

Universal fabric insulating tape combines essential properties such as noise damping, abrasion resistance, and strong bonding, while allowing wires to retain their flexibility, making the installation process easier.

19 MM X 15 M

KTM: **20-N08**

100 pcs 5 905694 023845

19 MM X 25 M

KTM: **20-N09**

100 pcs 5 905694 023852

ELECTRICAL TAPE



NEW

Suitable for electrical applications, such as insulating or marking wires.

KTM: **20-N10**

192 pcs 5 905694 023869

ELECTRICAL TAPE



NEW

Suitable for electrical applications, such as insulating or marking wires.

KTM: **20-N11**

192 pcs 5 905694 023876

UPHOLSTERY PIN PULLER



NEW

Puller for removing plastic clips and upholstery clips.

KTM: **20-N12**

120 pcs 5 905694 023883

SET OF HOOKS WITH HANDLE



NEW

The hook set with handles features hardened and chrome-plated tips made from resilient and durable steel. This set is recommended for automotive work, mechanical servicing, general maintenance, and construction.

KTM: **20-N13**

96 pcs 5 905694 023890

BLOW GUN WITH TWO TIPS



NEW

Blow gun with a long nozzle. Essential for removing dust, sand, shavings, etc., using compressed air.

KTM: **20-N14**

50 pcs 5 905694 023906

## W4 CV JOINT BOOT CLAMPS

CLAMPS FOR MOUNTING RUBBER CV JOINT BOOTS,  
MADE OF HIGH-QUALITY CHROME-NICKEL STAINLESS STEEL 4 (AISI304)

They ensure a durable and reliable connection and exhibit very high resistance to corrosion. The clamps are available in two sizes: 25-50 mm and 40-110 mm, and are packaged in plastic bags containing 10 pieces each.



KTM	Product	Max. Assembly (Nm)*	Max. Pressure (Bars)*	Quantity pcs. per package	Quantity per box pcs.	EAN
20-H025/50	Stainless steel hose clamp W4 25-50 / 7 mm	-	-	10	2500	5905694021766
20-H040/110	Stainless steel hose clamp W4 40-110 / 7 mm	-	-	10	1000	5905694021773

# HOSE CLIP / STAINLESS JUBILEE CLIPS W2

## HOSE CLIP

JUBILEE CLIP IS DESIGNED FOR SETTING HOSES WITH 9 MM TAPE MADE OF STAINLESS STEEL W2 (AISI 430)



Thanks to a custom lock housing design, the MA Professional W2 clip for elastic hoses is characterized by excellent parameters, while maintaining very compact size.

The cold-formed ribbing combined with slightly elevated edges provides protection of the elastic hose against all damage. Made of corrosion-resistant AISI-430 steel (tape and lock housing), the clips are an attractive option for the automotive industry. Due to their high corrosion resistance and good plastic parameters, the rust-proof W2 hose clip is also very popular on other technical markets. The recommended mounting moment depends on the size of the clip and should be matched to the hose type and the connection geometry.

### MATERIALS USED:

- **Screw:**  
Qst 36-3 soft steel (DIN 1.0213)  
Zinc-plated, with white-silver passivation (Cr3)
- **Tape and lock:**  
X6Cr17 stainless steel (DIN 1.4016) (AISI-430)

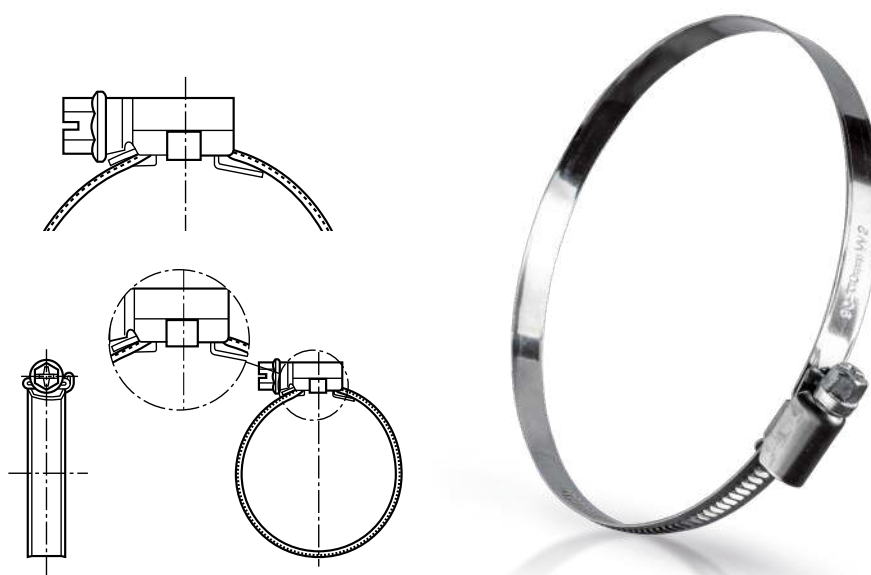

KTM	Product	Max.Assembly (Nm)*	Max. Pressure (Bars)*	Quantity pcs. per package	Quantity per box pcs.	EAN
20-F006/16	Hose clamp stainless steel W2 6-16 / 9 mm	2	15	20	1000	5905694021605
20-F008/12	Hose clamp stainless steel W2 8-12 / 9 mm	2	15	20	1000	5905694018971
20-F010/16	Hose clamp stainless steel W2 10-16 / 9 mm	3	40	20	1000	5905694018988
20-F012/22	Hose clamp stainless steel W2 12-22 / 9 mm	3	40	20	1000	5905694018995
20-F016/27	Hose clamp stainless steel W2 16-27 / 9 mm	3,5	38	20	1000	5905694019008
20-F020/32	Hose clamp stainless steel W2 20-32 / 9 mm	3,5	36	20	1000	5905694019015
20-F025/40	Hose clamp stainless steel W2 25-40 / 9 mm	4	32	20	1000	5905694019022
20-F032/50	Hose clamp stainless steel W2 32-50 / 9 mm	4	28	20	1000	5905694019039
20-F040/60	Hose clamp stainless steel W2 40-60 / 9 mm	4	24	20	500	5905694019046
20-F050/70	Hose clamp stainless steel W2 50-70 / 9 mm	4	19	20	500	5905694019053
20-F060/80	Hose clamp stainless steel W2 60-80 / 9 mm	4	17	10	500	5905694019060
20-F070/90	Hose clamp stainless steel W2 70-90 / 9 mm	4	15	10	500	5905694019077
20-F080/100	Hose clamp stainless steel W2 80-100 / 9 mm	4	13	10	500	5905694019084
20-F090/110	Hose clamp stainless steel W2 90-110 / 9 mm	4	11	10	500	5905694019091
20-F100/120	Hose clamp stainless steel W2 100-120 / 9 mm	4	10	10	250	5905694019107
20-F110/130	Hose clamp stainless steel W2 110-130 / 9 mm	4	9	10	250	5905694019114
20-F120/140	Hose clamp stainless steel W2 120-140 / 9 mm	4	8	10	250	5905694019121
20-F130/150	Hose clamp stainless steel W2 130-150 / 9 mm	4	7	10	250	5905694019138
20-F140/160	Hose clamp stainless steel W2 140-160 / 9 mm	4	6	10	250	5905694019145

\* The maximum application pressure can vary depending on the type of hose used and the geometry of the coupling.



## BLACK PLASTIC CLAMPS

Black mounting ties made of high-quality PA66 polyamide, resistant to UV radiation. They retain their properties in a wide temperature range, from -40°C to + 85°C. Flammability class 94V-2. A wide range of applications, e.g. strapping and bundling cables, assembly elements and many others.

Available in a variety of sizes. Packed in 50 and 100 pieces



KTM	Description	Dimensions	Quantity in the package unit	Quantity in the package	EAN
20-H01	MA Professional - Black plastic clamps	2,5 mm x 80 mm	100	60000	5905694011361
20-H02	MA Professional - Black plastic clamps	2,5 mm x 100 mm	100	50000	5905694011767
20-H03	MA Professional - Black plastic clamps	2,5 mm x 120 mm	100	50000	5905694011774
20-H04	MA Professional - Black plastic clamps	2,5 mm x 160 mm	100	25000	5905694011781
20-H05	MA Professional - Black plastic clamps	2,5 mm x 200 mm	100	25000	5905694011798
20-H06	MA Professional - Black plastic clamps	3,6 mm x 140 mm	100	25000	5905694011804
20-H07	MA Professional - Black plastic clamps	3,6 mm x 200 mm	100	20000	5905694011811
20-H08	MA Professional - Black plastic clamps	3,6 mm x 250 mm	100	20000	5905694012399
20-H09	MA Professional - Black plastic clamps	3,6 mm x 300 mm	100	15000	5905694012405
20-H10	MA Professional - Black plastic clamps	3,6 mm x 370 mm	100	10000	5905694022664
20-H11	MA Professional - Black plastic clamps	4,8 mm x 120 mm	100	20000	5905694012429
20-H12	MA Professional - Black plastic clamps	4,8 mm x 160 mm	100	15000	5905694022671
20-H13	MA Professional - Black plastic clamps	4,8 mm x 180 mm	100	15000	5905694012443
20-H14	MA Professional - Black plastic clamps	4,8 mm x 200 mm	100	15000	5905694022688
20-H15	MA Professional - Black plastic clamps	4,8 mm x 250 mm	100	10000	5905694022695
20-H16	MA Professional - Black plastic clamps	4,8 mm x 300 mm	100	10000	5905694022701
20-H17	MA Professional - Black plastic clamps	4,8 mm x 370 mm	100	10000	5905694022718
20-H18	MA Professional - Black plastic clamps	4,8 mm x 430 mm	100	5000	5905694022725
20-H19	MA Professional - Black plastic clamps	4,8 mm x 500 mm	100	5000	5905694022732
20-H20	MA Professional - Black plastic clamps	7,6 mm x 200 mm	50	5000	5905694022749
20-H21	MA Professional - Black plastic clamps	7,6 mm x 250 mm	50	5000	5905694022756
20-H22	MA Professional - Black plastic clamps	7,6 mm x 300 mm	50	5000	5905694022763
20-H23	MA Professional - Black plastic clamps	7,6 mm x 370 mm	50	5000	5905694022770
20-H24	MA Professional - Black plastic clamps	7,6 mm x 450 mm	50	2500	5905694022787
20-H25	MA Professional - Black plastic clamps	9,0 mm x 450 mm	50	2000	5905694022794
20-H26	MA Professional - Black plastic clamps	9,0 mm x 750 mm	50	1000	5905694022800
20-H27	MA Professional - Black plastic clamps	9,0 mm x 920 mm	50	1000	5905694022817
20-H28	MA Professional - Gray plastic band for hubcaps	3,6 mm x 370 mm	100	10000	5905694022312





## WHITE PLASTIC CLAMPS

White mounting ties made of high-quality PA66 polyamide, resistant to UV radiation. They retain their properties in a wide temperature range, from -40°C to + 85°C. Flammability class 94V-2. A wide range of applications, e.g. strapping and bundling cables, assembly elements and many others. Available in a variety of sizes. Packed in 50 and 100 pieces.



KTM	Description	Dimensions	Quantity in the package unit	Quantity in the package	EAN
14-200	TECMAXX - White plastic clamps	2,5 mm x 80 mm	100	60000	5905694016335
14-201	TECMAXX - White plastic clamps	2,5 mm x 100 mm	100	50000	5905694016656
14-202	TECMAXX - White plastic clamps	2,5 mm x 120 mm	100	50000	5905694018551
14-203	TECMAXX - White plastic clamps	2,5 mm x 160 mm	100	25000	5905694018605
14-204	TECMAXX - White plastic clamps	2,5 mm x 200 mm	100	25000	5905694020592
14-205	TECMAXX - White plastic clamps	3,6 mm x 140 mm	100	25000	5905694020608
14-206	TECMAXX - White plastic clamps	3,6 mm x 200 mm	100	20000	5905694020615
14-207	TECMAXX - White plastic clamps	3,6 mm x 250 mm	100	20000	5905694020622
14-208	TECMAXX - White plastic clamps	3,6 mm x 300 mm	100	15000	5905694020639
14-209	TECMAXX - White plastic clamps	3,6 mm x 370 mm	100	10000	5905694020646
14-210	TECMAXX - White plastic clamps	4,8 mm x 120 mm	100	20000	5905694020653
14-211	TECMAXX - White plastic clamps	4,8 mm x 160 mm	100	15000	5905694020660
14-212	TECMAXX - White plastic clamps	4,8 mm x 180 mm	100	15000	5905694020677
14-213	TECMAXX - White plastic clamps	4,8 mm x 200 mm	100	15000	5905694020684
14-214	TECMAXX - White plastic clamps	4,8 mm x 250 mm	100	10000	5905694020691
14-215	TECMAXX - White plastic clamps	4,8 mm x 300 mm	100	10000	5905694020707
14-216	TECMAXX - White plastic clamps	4,8 mm x 370 mm	100	10000	5905694020714
14-217	TECMAXX - White plastic clamps	4,8 mm x 430 mm	100	5000	5905694020721
14-218	TECMAXX - White plastic clamps	4,8 mm x 500 mm	100	5000	5905694020738
14-219	TECMAXX - White plastic clamps	7,6 mm x 200 mm	50	5000	5905694020745
14-220	TECMAXX - White plastic clamps	7,6 mm x 250 mm	50	5000	5905694020752
14-221	TECMAXX - White plastic clamps	7,6 mm x 300 mm	50	5000	5905694020769
14-222	TECMAXX - White plastic clamps	7,6 mm x 370 mm	50	5000	5905694020776
14-223	TECMAXX - White plastic clamps	7,6 mm x 450 mm	50	2500	5905694020783
14-224	TECMAXX - White plastic clamps	9,0 mm x 450 mm	50	2000	5905694020790
14-225	TECMAXX - White plastic clamps	9,0 mm x 750 mm	50	1000	5905694020806
14-226	TECMAXX - White plastic clamps	9,0 mm x 920 mm	50	1000	5905694020813



# technical chemistry

**TECMAXX**

The **Tecmaxx** technical product line offers a wide variety of products for both amateur and professional users. The Tecmaxx product selection includes various greases, technical vaseline, universal and technical cleaner, degreasers, compressed air, as well as stainless steel, fireplace and grill cleaning products.



[tecmaxx.pl](http://tecmaxx.pl)

**SILICONE GREASE**



Lubricant for precision elements. Resistant to high and low temperatures and water. Application: metal, plastic, rubber, wood.

KTM: **14-001**  
 Cap.: 250 ml  
 24 pcs 5 905694 015314

**WHITE GREASE**



Ensures long-lasting lubrication. A grease with high penetrating properties. Resistant to rinsing and temperature. It does not drip off vertical surfaces.

KTM: **14-002**  
 Cap.: 200 ml  
 24 pcs 5 905694 015321

**PTFE GREASE**



PTFE particles effectively adhere to metals, reduce friction and increase resistance to corrosion. Resistant to salt and water.

KTM: **14-016**  
 Cap.: 400 ml  
 24 pcs 5 905694 016526

KTM: **14-003**  
 Cap.: 200 ml  
 24 pcs 5 905694 015338

**COPPER GREASE**



It protects metal parts working at a high temperature against corrosion and thermal distortion. It reduces friction of metal parts, protects bearings, corroded nuts and screws, protects against thermal distortion in extreme conditions.

KTM: **14-004**  
 Cap.: 200 ml  
 24 pcs 5 905694 015345

**PENETRANT**



Gives quick and strong effect. It cleans and loosens seized parts. Water resistant.

KTM: **14-005**  
 Cap.: 250 ml  
 24 pcs 5 905694 015352

**TECHNICAL VASELINE**



High-quality protective agent. A lubricant for all lightly loaded mechanisms. It protects battery clamps against oxidation.

KTM: **14-007**  
 Cap.: 200 ml  
 24 pcs 5 905694 015376

**PADLOCK AND LOCK LUBRICANT**



Product for all types of locks and padlocks. Prevents from blocking. Defrosts instantly, lubricates and preserves.

KTM: **14-008**  
 Cap.: 100 ml  
 24 pcs 5 905694 015383

**MACHINE GREASE**



Strengthened grease resistant to high loads, pressure, vibrations, shaking and centrifugal forces. It has strong penetrating properties so it penetrates deeply without the need to disassemble. Intended for machine parts and moving elements.

KTM: **14-013**  
 Cap.: 250 ml  
 24 pcs 5 905694 015451

**LITHIUM GREASE LT-43**



Water resistant grease of high mechanical stability. It lubricates mechanical elements, rolling and slide bearings, etc. perfectly.

KTM: **14-015**  
 Cap.: 400 ml  
 24 pcs 5 905694 015475

**GATE GREASE WITH APPLICATOR**



Product used for lubrication, maintenance and protection against moisture and corrosion. It is suitable for all types of gates: traditional, vertical tilt, roller-shutter, sliding and leaf gates. It improves the operation of hardy operating mechanisms.

KTM: **14-022**  
 Cap.: 400 ml  
 24 pcs 5 905694 017363

**CUTTING AND DRILLING OIL**



Cutting and drilling oil is used to cool and lubricate during drilling, cutting, lathework and bending. It is suitable for working of alloyed and unalloyed steel, cast iron, chromium-nickel alloys, copper, titanium, aluminum and its alloys.

KTM: **14-030**  
 Cap.: 400 ml  
 12 pcs 5 905694 017141

**GRAPHITE GREASE**



Grease with the addition of graphite. Highly resistant to water and temperature. It protects against rust and corrosion.

KTM: **14-025**

Poj. 50 g  
12 pcs



**SILICONE GREASE**



For various types of surfaces, e.g. plastics, rubber, wood. It creates a coat of unique durability, ensures maximum reduction of friction and long operation of protected devices. Resistant to water.

KTM: **14-026**

Poj. 50 g  
12 pcs



**COPPER GREASE**



A multi-purpose agent that can be used in the most difficult conditions. Resistant to temperatures from -30°C to 1200°C. For lubrication of bolts, nuts, threaded connections and any matching surfaces, pipe fittings, etc.

KTM: **14-027**

Poj. 50 g  
12 pcs



**SYNTHETIC GREASE**



Multi-purpose grease for very difficult conditions. It is highly water resistant. For use in industries with difficult working conditions (moisture, loads, high temperature, dust, etc.).

KTM: **14-028**

Poj. 50 g  
12 pcs



**LITHIUM GREASE**



Multi-purpose grease for lubrication of elements and systems in industrial, agricultural vehicles and cars. It ensures effective lubrication even under the harshest operating conditions. Resistant to water and oxidation.

KTM: **14-029**

Poj. 50 g  
12 pcs



**CERAMIC GREASE**



A highly adhesive ceramic grease resistant to extreme loads and temperatures up to 1400°C. It excellently protects highly loaded elements exposed to weather conditions from wear. It secures metal parts against corrosion and electrolytic corrosion. It does not contain metals.

KTM: **14-054**

Cap.: 50 g  
12 pcs



NEW

**MACHINE GREASE**



Multi-purpose grease. Resistant to temperature from -10°C to +60°C and resistant to water. It forms a layer protecting against moisture, temperature and contamination. For lubrication of plain bearings and other friction surfaces - except for bearings rolling.

KTM: **14-023**

Cap.: 500 ml  
12 pcs



**BEARING LUBRICANT**



Lubricant for rolling and slide bearings, other friction surfaces operating under normal conditions, in the temperature range from -30°C to +130°C. Water resistant.

KTM: **14-024**

Cap.: 500 ml  
12 pcs



**THREADLOCKER BLUE  
- MEDIUM STRENGTH**



Thread-locking fluid, medium force. Prevents loosening of joints. Seals joints. Prevents corrosion.

KTM: **14-033**  
Cap.: 6 ml  
12 pcs 5 905694 017745

KTM: **14-035**  
Cap.: 10 ml  
12 pcs 5 905694 019251

**THREADLOCKER RED  
- HIGH STRENGTH**



Thread-locking fluid, strong force. Prevents loosening of joints. Seals joints. Prevents corrosion. Withstands high loads.

KTM: **14-034**  
Cap.: 6 ml  
12 pcs 5 905694 017738

KTM: **14-036**  
Cap.: 10 ml  
12 pcs 5 905694 019268

**RUST REMOVER MoS<sub>2</sub>**



**NEW**

A solution for removing oxides from metal surfaces. It facilitates the loosening of rusted bolts, nuts, and spark plugs. The high-quality oil and MoS<sub>2</sub> additive ensure that the metal surface is lubricated and permanently protected. It safeguards metal from weather conditions and corrosion.

KTM: **14-051**  
Cap.: 400 ml  
24 pcs 5 905694 024064

**RUST REMOVER MoS<sub>2</sub>  
APPLICATOR**



**NEW**

A solution for removing oxides from metal surfaces. It facilitates the loosening of rusted bolts, nuts, and spark plugs. The high-quality oil and MoS<sub>2</sub> additive ensure that the metal surface is lubricated and permanently protected. It safeguards metal from weather conditions and corrosion.

KTM: **14-052**  
Cap.: 500 ml  
24 pcs 5 905694 024071

**CERAMIC LUBRICANT**



**NEW**

Ceramic grease for bolts and connections exposed to high pressure and temperatures up to 1400°C. It prevents the seizing of bolts and metal connections made of steel, noble alloys, copper, and aluminum in industrial applications.

KTM: **14-053**  
Cap.: 400 ml  
24 pcs 5 905694 024088

**COMPRESSOR OIL**



**NEW**

High-quality oil L-DAH 100 is designed for the lubrication of single and multi-stage air compressors, including reciprocating, rotary, and rotary vane compressors, where the oil temperature in the compression phase does not exceed 150 degrees. This oil is dedicated to equipment operating under medium conditions. It features low foaming and good air release. The product provides excellent anti-corrosion and anti-wear properties and is highly resistant to oxidation and coking.

KTM: **14-058**  
Cap.: 11  
12 pcs 5 905694 024279

DEGREASER



Agent removing greasy dirt. It dissolves old greasy sediments such as oils and lubricants, removes dirt layers perfectly.

KTM: **14-009**  
 Poj. 1 L  
 12 pcs  
 5 905694 015390

ALUMINUM CLEANER



Product intended for cleaning and degreasing surfaces made of aluminum and its alloys. It can also be used to clean surfaces made of other metals.

KTM: **14-019**  
 Cap.: 1 L  
 12 pcs  
 5 905694 016977

ENGINE CLEANER



Very strong and effective product intended for washing engines and car components. It removes oils and lubricants from the cleaned surfaces and other persistent dirt perfectly and quickly.

KTM: **14-020**  
 Cap.: 1 L  
 12 pcs  
 5 905694 016984

NEUTRAL CLEANER



Universal washing and cleaning agent. Degreases and washes tools, garden equipment, car parts and elements made of plastic.

KTM: **14-021**  
 Cap.: 1 L  
 12 pcs  
 5 905694 016991

TECHNICAL CLEANER



Washing and cleaning agent for dirt in garage, workshop and other spaces. It removes burnt oil, carbon deposits, grease and other stubborn dirt.

KTM: **14-010**  
 Cap.: 650 ml  
 12 pcs  
 5 905694 015406

GRILL CLEANER



Agent with a very strong effect. Removes burnt-in fat and smoke. Dissolves and removes burnt-on food.

KTM: **14-011**  
 Cap.: 650 ml  
 12 pcs  
 5 905694 015413

FIREPLACE CLEANING FOAM



Foam for windows and fireplace inserts. Removes smoke, burnt wood deposits, soot, tar compounds and burnt-on fat perfectly.

KTM: **14-012**  
 Cap.: 650 ml  
 12 pcs  
 5 905694 015420

**STAINLESS STEEL  
CLEANER**



An easy-to-use agent intended for cleaning surfaces and elements made of stainless steel and aluminum. It degreases perfectly. It prepares surfaces for further work.

KTM: **14-017**  
Cap.: 650 ml  
12 pcs 5 905694 016533

**APC OUT  
PREPARATION FOR CLEANING ROOFS AND FACADES**



Highly foaming, alkaline cleaning fluid for cleaning roofs, facades, paving stones. Removes atmospheric dirt, dirt of organic origin (plants, insects), stains. Fluid is a concentrate suitable for manual washing, washing with the use of pressure and foam-generating devices.

KTM: **14-044**  
Cap.: 1 l  
12 pcs 5 905694 023050

KTM: **14-045**  
Cap.: 5 l  
1 pcs 5 905694 023067

**MECH OUT  
PREPARATION FOR REMOVING MOSS AND LICHENS**



A cleaning product for surfaces contaminated with moss, lichens, and fungi. It is excellent for cleaning roofs and facades. Effectively removes dirt, mold, and lichens from all types of surfaces, including wood, masonry, concrete, tiles, and facades.

KTM: **14-046**  
Cap.: 1 l  
12 pcs 5 905694 023234

KTM: **14-047**  
Cap.: 5 l  
1 pcs 5 905694 023241

**ACTIVE FOAM**



Foaming preparation, contoured and softens dirt. It has a neutral PH - can be used on different types of surfaces. Thanks to its unique formula, it is characterized by high efficiency. Perfectly removes dirt, dust and other grime. Can be used for washing cars.

KTM: **14-048**  
Cap.: 1 kg  
6 pcs 5 905694 023937

KTM: **14-049**  
Cap.: 5 kg  
1 pcs 5 905694 023944





**BRAKE CLEANER  
PREPARATION  
FOR CLEANING BRAKE DISCS**



**NEW**

A product for cleaning brake discs. A quick-drying agent for degreasing brake discs, clutch components, and other metal parts. It effectively and rapidly removes contaminants from metal surfaces.

KTM: **14-056**  
Cap.: 500 ml  
30 pcs



**TECHNICAL POWER CLEANER**



**NEW**

A strong, intensive degreaser with the addition of acetone intended for quick removal of protective maintenance and heavy dirt from wax, rubber, silicone, oil, grease, glue, resins, paints, etc. Perfect for washing and degreasing machine parts before service and assembly and varnishing. Perfectly dissolves difficult contaminants and leaves the surface perfectly degreased.

KTM: **14-060**  
Cap.: 600 ml  
12 pcs



**SEAT BELT SPRAY**



**NEW**

Preparation for regenerating seat belts. Supports their operation. After use, it restores smooth rolling and unwinding of the belts. Eliminates the problem of rolling and unwinding without the need for mechanical repair. Leaves a pleasant citrus scent. Leaves no marks on clothing.

KTM: **14-062**  
Cap.: 250 ml  
24 pcs



**EPOXY METAL 5 MINUTES  
- SYRINGE**



**NEW**

Tecmax Epoxy Metal 5 min is a fast-curing epoxy-steel compound designed for repairing damaged or cracked items made from various metal alloys, wood, ceramics, plastics, and many other materials. The product forms a very hard bond resistant to temperatures up to 150°C and is also resistant to automotive, transmission, and hydraulic oils, gasoline, water, and many other substances.

KTM: **14-057**  
Cap.: 25 ml  
12 pcs



**EPOXY CLEAR  
5 MINUT - SYRINGE**



**NEW**

A fast-drying transparent epoxy adhesive designed for repairing damaged or cracked items made from various hard materials such as steel, plastic, wood, ceramics, glass, and many others. It forms a very hard bond that is resistant to weather conditions and temperatures up to 80°C.

KTM: **14-059**  
Cap.: 25 ml  
12 pcs



**SUPER METAL EXTREME  
70% STALI 10 MIN.**



**NEW**

A top-quality epoxy-steel repair compound containing 70% steel, designed for quick and durable repair of damaged metal components. It quickly hardens to form a very tough bond resistant to weather conditions, chemicals, and temperatures ranging from -60°C to 120°C. Once fully cured, the bond can be mechanically processed or painted. The compound has exceptional properties for filling material gaps.

KTM: **14-061**  
Cap.: 25 ml  
12 pcs



# The Video Academy

## AMTRA Product knowledge base

Welcome to the **AMTRA API VIDEO ACADEMY**. Here, through our instructional videos, you will learn in an easy-to-understand way all the functions and possibilities for capturing data on Amtra products embedded in the API Index Knowledge Base.

We wish you a pleasant use of our video materials and resources!



## The Video Academy



Product search



Data export



Navigating the knowledge base



Creating views and working on your own assortment



Permissions do logged-in users gain



Search the **PRODUCTS**, you are interested in ...

## API AMTRA FULL INTEGRATION with AMTRA ON-LINE catalogue

Always **UP-TO-DATE** and functional  
**KNOWLEDGE BASE** on AMTRA indices



download



export



share

**API AMTRA** is a database containing information on product indices from the current Amtra Group offer collected in one place - such as: product name, KTM, marketing description, link to the photo, link to the MSDS card.

**REGISTER IN  
API AMTRA**





RUBBER



LEATHER



PLASTIC



METAL



FABRICS



WOOD



CERAMICS



GLASS

# BONDINI

## cyanoacrylate adhesives

Cyanoacrylate adhesives, more commonly known as instant or super glues, are excellent solutions for various bonding and repair tasks. **BONDINI PLUS** and **BONDINI BLACK** are high-quality adhesives that bond many different materials in just a few seconds. They are perfect for both household and industrial applications. The short bonding time combined with high bond strength makes these adhesives ideal tools for demanding users. The glue never hardens in the applicator because it features a unique cap with a special needle inside that seals the glue nozzle. When the cap is unscrewed, the needle unblocks the nozzle, ensuring the glue is always ready for use.

**BONDINI BLACK**  
BLACK CYANOACRYLATE ADHESIVE



**BONDINI PLUS**  
CYANOACRYLATE ADHESIVE

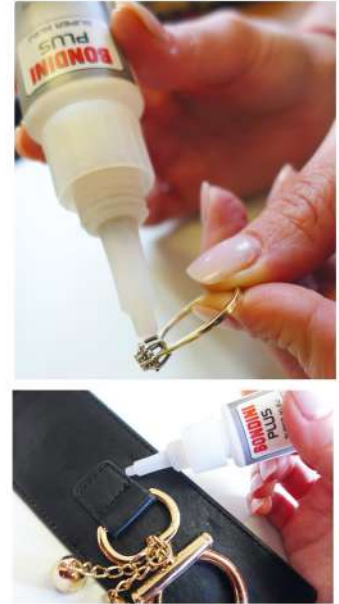

Bonds permanently in 10 seconds. Super strong. Waterproof. Flexible. Always ready to use. It features a unique dispenser and a cap with a needle that prevents clogging. The black color makes it ideal for bonding rubber, leather, plastic components, metal, and more.

Bonds permanently in 10 seconds. Super strong. Always ready to use. Features a unique dispenser and a cap with a needle that prevents clogging.

Adheres to:

- wood
- glass
- ceramics
- metal
- leather
- rubber
- fabrics

KTM: **02-041**  
Cap.: 6 g  
24 pcs 5 905694 018230

KTM: **02-030**  
Cap.: 500 g  
1 pcs 5 905694 009528





**Clinex<sup>®</sup>**  
**EXPERT<sup>+</sup>**

# professional car wash chemicals

The Clinex Expert+ product line created by AMTRA is an excellent offer for car washes. It is a Polish brand encompassing high quality, specialist products for professional hand washing: vehicles, workshops, halls and industrial machinery.



clinex.com.pl



information  
& application

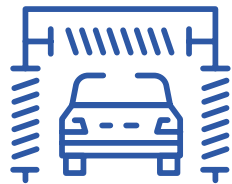

APPLICATION

	pH	External elements	Bodywork	Tilt	Van trailer	Refrigerator/Isotherm	Rim	Tire	Engine	Glass	Interior elements
BIO ACTIVE CAR	10	✓	✓								
NEUTRAL ACTIVE FOAM	7	✓	✓								
DIMMEX 2	14	✓		✓	✓	✓	✓		✓		
INSEKT	12	✓	✓							✓	
SHAMPOO WAX	10	✓	✓								
SHAMPOO BLUE	10	✓	✓								
ACTIVE TRUCK NF	13	✓		✓	✓	✓					
WAXCAR	3	✓	✓	✓	✓	✓				✓	
POLIWAXCAR	3,5	✓	✓	✓	✓	✓				✓	
QUICK SHINE	-	✓	✓							✓	
ENGINE	13	✓							✓		
ALUM	-	✓					✓				
TYRE SHINE	-	✓						✓			
PLASTICAR	13										✓
BIO KOKPIT FRESH / LEMON	5										✓
KOKPIT WAX	5,5										✓
TEXTICAR	10										✓
LEATHER CLEANER	-										✓
LEATHER CONDITIONER	-										✓

### BIO ACTIVE CAR ACTIVE FOAM FOR MANUAL AND TOUCHLESS WASHING



Foaming preparation for frequent car bodywork washing. Thanks to its unique formulation, it is characterized by high effectiveness in action. It perfectly removes dirt, dust, and other road dirt.

KTM: **40-001**  
Cap.: 1 L  
1 pc 5 905694 002000

KTM: **40-002**  
Cap.: 5 L  
1 pc 5 905694 002017

KTM: **40-004**  
Cap.: 20 L  
1 pc 5 905694 002031

### NEUTRAL ACTIVE FOAM NEUTRAL ACTIVE FOAM FOR VEHICLE WASHING



Concentrated active foam with neutral pH for safe and effective car body washing. Thanks to the use of modern technology, it is safe for vehicles coated with various types of waxes, quartz, and ceramic coatings. The product has a pleasant scent and high foaming properties, and it rinses off easily.

KTM: **40-005**  
Cap.: 5 L  
1 pc 5 905694 015710

KTM: **40-006**  
Cap.: 20 L  
1 pc 5 905694 015727

### DIMMEX 2 A STRONG FOAMING PREPARATION FOR TOUGH STAINS REMOVAL



Strongly concentrated, foaming preparation for preliminary and basic cleaning. It effectively dissolves and removes road dirt, grease, lubricants, and other stubborn stains even without the use of a brush or sponge.

KTM: **40-012**  
Cap.: 5 kg  
1 pc 5 905694 015734

KTM: **40-014**  
Cap.: 25 kg  
1 pc 5 905694 015758

### INSEKT LIQUID FOR INSECTS REMOVAL



A preparation for removing insects and organic contaminants (tree sap, bird droppings, etc.) from bodies, windows, headlights, bumpers. It leaves no streaks after rinsing.

KTM: **40-021**  
Cap.: 5 L  
1 pc



5 905694 002208

### SHAMPOO WAX CAR SHAMPOO WITH WAX



Shampoo with added natural wax designed for washing both personal and commercial vehicles. Its specific composition protects the car's paintwork from the negative effects of atmospheric and road factors. It effectively removes strong dirt, has a preservative effect, and adds shine. It allows for simultaneous car washing and waxing.

KTM: **40-032**  
Cap.: 5 L  
1 pc



5 905694 002314

### SHAMPOO BLUE CAR SHAMPOO - CONCENTRATE



Shampoo designed for washing both personal and commercial vehicles. It effectively dissolves and removes road contaminants and other stubborn dirt, while protecting the cleaned surfaces from becoming dull. After rinsing, it does not leave streaks.

KTM: **40-089**  
Cap.: 20 L  
1 pc



5 905694 002673

### ACTIVE TRUCK NF FOAMING PREPARATION FOR PRELIMINARY AND TOUCHLESS CLEANING



A concentrated and highly foaming preparation for cleaning the bodies of mechanical vehicles. Thanks to a unique formula, it is characterized by high efficiency. It perfectly removes dirt, dust, and other contaminants. Avoid using the product on heated surfaces.

KTM: **40-100**  
Cap.: 5 kg  
1 pc 5 905694 013150

KTM: **40-101**  
Cap.: 26 kg  
1 pc 5 905694 011897



5 905694 011897



## WAXING PREPARATIONS

### WAXCAR WET DRYING WAX



A cationic hydro wax that provides painted surfaces with long-lasting hydrophobic action, shine, and conservation. Thanks to modern technology, the product has excellent properties for softening even very hard water, which enables its faster and even more effective action. The antistatic substances used in the preparation effectively protect the paint from the effects of external factors. It does not leave streaks and stains on the surface.

KTM: **40-064**  
Cap.: 5 L  
1 pc  
5 905694 002628

### POLIWAXCAR POLYMER WAX FOR BODY CONSERVATION



A concentrated, cationic hydro wax that provides painted surfaces with long-lasting hydrophobic action, high gloss, and conservation. Thanks to the content of polymers and antistatic substances, it effectively protects the paint from the effects of external factors. It does not leave streaks and stains on the surface. Applied after active foam, it facilitates its rinsing and speeds up the vehicle drying time.

KTM: **40-065**  
Cap.: 5 L  
1 pc  
5 905694 015086

### QUICK SHINE QUICK GLOSS WAX



A rapid polishing wax that protects the paint from dust settling, provides an instant shine and paint protection. It enhances the natural colour of the paint and protects it from UV radiation. It can be applied to any external surfaces of the vehicle, such as windows, plastics or rubber elements.

KTM: **40-105**  
Cap.: 5 L  
6 pcs  
5 905694 013341

## PREPARATIONS FOR ENGINES AND RIMS

### ENGINE LIQUID FOR THE ENGINE AND CAR COMPONENTS



A preparation for cleaning the engine and other car components. Thanks to the content of organic solvents, it removes even the most difficult dirt to remove caused by oil or other petroleum products. Avoid using the product on heated surfaces. Do not use on painted parts.

KTM: **40-044**  
Cap.: 650 ml  
1 pc  
5 905694 002437

### ALUM ALUMINUM CLEANING PREPARATION - ACIDIC



A slightly foaming preparation for cleaning aluminum elements such as rims, sides, radiators, etc. It perfectly removes dirt, brake pad deposits, water deposits, and contaminants from the settling of iron oxides.

KTM: **40-017**  
Cap.: 5 L  
1 pc  
5 905694 002161

## TYRES & RIMS

### TYRE SHINE PREPARATION FOR POLISHING TIRES AND CONSERVING THEM



A silicone-based preparation for the conservation and polishing of elements made of rubber. Thanks to its unique formula, it is quickly absorbed into the rubber surface, making it flexible and preventing its chapping (peeling and discoloration). It gives a wet tire effect, and protects seals from freezing. It can also be used for the conservation of external plastic car finish elements.

KTM: **40-073**  
Cap.: 5 L  
1 pc  
5 905694 002741

### PLASTICAR UNIVERSAL CLEANING AGENT



A cleaning and maintenance preparation for car dashboards and other surfaces made of plastic, both inside and outside the vehicle. It leaves a satin shine on the cleaned surfaces, protecting them from UV action. The preparation does not discolour the cleaned surfaces, and thanks to its antistatic action, it prevents dust from settling.

KTM: **40-060**  
Cap.: 5 L  
1 pc 5 905694 002581

### BIO KOKPIT FRESH / LEMON PREPARATION FOR PLASTIC RENOVATION



Dashboard care milk. It cleans and maintains plastic elements inside the car. It gives a shine to unpainted bumpers, spoilers, and rubber. It does not grease, acts antistatically and makes dust settling difficult.

Bio Cockpit Fresh  
KTM: **40-067**  
Cap.: 5 L  
1 pc 5 907513 270843

Bio Cockpit Lemon  
KTM: **40-068**  
Cap.: 5 L  
1 pc 5 907513 270836

### KOKPIT WAX PREPARATION FOR CLEANING AND MAINTAINING DASHBOARDS



A cleaning and maintenance preparation for car dashboards and other surfaces made of plastic, both inside and outside the vehicle. It leaves a satin shine on the cleaned surfaces, protecting them from UV action. The preparation does not discolour the cleaned surfaces, and thanks to its antistatic action, it prevents dust from settling.

KTM: **40-108**  
Cap.: 1 L  
6 pcs 5 905694 013242

### TEXTICAR LIQUID FOR CAR'S UPHOLSTERY EXTRACTIVE CLEANING



A highly concentrated product that effectively and quickly removes stains from car upholstery and all types of fabrics. It provides an excellent cleaning effect, removes dirt and stains from the deeper layers of the fabric. It has cleaning and degreasing properties and prevents the re-deposition of dirt. It nourishes and revives colours. It works well even in cold and hard water.

KTM: **40-107**  
Cap.: 5 L  
1 pc 5 905694 013174

### LEATHER CLEANER LEATHER SURFACE CLEANER



A product for cleaning leather surfaces. Safe for the surface, it effectively removes dirt from micro-cracks without drying out the leather. It prepares the surface for the application of a care product.

KTM: **40-103**  
Cap.: 1 L  
6 pcs 5 905694 013358

### LEATHER CONDITIONER NOURISHING EMULSION FOR LEATHER SURFACES



A care and conservation product for leather and leather-like surfaces. It contains avocado oil, providing long-lasting protection for the leather. The product restores the elasticity of the leather and reduces the aging effect, extending its lifespan, moisturizing, and regenerating. Leather treated with the product does not dry out, fade, wear out, or crack, it regains its natural shine and softness.

KTM: **40-104**  
Cap.: 1 L  
6 pcs 5 905694 013440

**ACCESSORIES FOR CAR WASHES**

**SPRAYER 6L**  
Xi6 INDUSTRIAL SPRAYER



A manual sprayer for applying water-diluted preparations in a special chemically-resistant version. Particularly recommended for applying pre-wash preparations (active foams), wheel cleaning products, as well as for applying drying waxes.

KTM:	<b>40-069</b>	
Cap.:	6 L	
	1 pc	5 904447 009389

**CHAMOIS**  
EXPERT+ SYNTHETIC CHAMOIS



A very durable chamois with high water-absorbing properties, it does not leave streaks on paint and glass. Size 53 x 43 cm

KTM:	<b>40-070</b>	
Size:	53 x 43 cm	
	1 pc	5 905694 002697

**SPRAYER 1L**  
MERCURY PRO+ 1 LITRE SPRAYER  
CHEMICAL-RESISTANT



Hand sprayer for applying water-dilutable preparations in a special chemical-resistant version. Especially recommended for applying products for window cleaning, upholstery cleaning, plastic cleaning, as well as for applying drying waxes.

KTM:	<b>40-079</b>	
Cap.:	1 L	
	1 pc	5 904447 001499

**SPRAYER 1,5L**  
VENUS PRO+ 1.5 LITRE SPRAYER  
CHEMICAL-RESISTANT



Hand sprayer for applying water-dilutable preparations in a special chemical-resistant version. Especially recommended for applying pre-wash products (active foams), wheel cleaning products, as well as for applying drying waxes.

KTM:	<b>40-080</b>	
Cap.:	1,5 kg	
	1 pc	5 904447 001475



[amtra.co](https://amtra.co)



2016 - 2023

